



SPRINGFIELD

SPRINGFIELD MARINE

MASTER CATALOG



ED: 10-24.A

DIAGRAM A

DIAGRAM B

Springfield Marine Company pioneered the marine seating market and today is a leading provider of marine seating, seating & table hardware, and boarding ladders to customers around the world. The company continues to develop products to meet the growing needs / wants of boaters, while maintaining the highest industry standards for safety, durability, and comfort. To ensure quality and customer satisfaction, Springfield Marine products meet the following testing standards and certifications:

- **American Boating & Yacht Council (ABYC) Standards (USA)**
- **Certificate of type approval of China Classification Society (CCS)**
- **DNV Business Assurance Management System Certificate (DNV)**
- **Type Approval Certificate (BV)**
- **EC Type-Examination Certificate**

Regardless of brand, all electrical and/or electronic components are covered only for one year from date of sale to first use purchaser.

Springfield Marine branded products are backed by the following warranty terms:

HARDWARE - 5-Year Limited Warranty: Pedestals, Mounts & Accessories

For a period of 5 years from the date of sale to the first use purchaser, Springfield Marine Company will replace product which proves to have manufacturer's defect in materials and workmanship under normal and proper usage.

SEATING - 1-Year Limited Warranty: Upholstery, Cushions & Electrical Components

For a period of 1 year from the date of sale to the first use purchaser, Springfield Marine Company will replace any upholstered product which proves to have manufacturer's defect involving vinyl, fabric, leather or foam components in materials and workmanship under normal and proper usage.

SEATING - 5-Year Limited Warranty: Frame & Substrate

For a period of 5 years from the date of sale to the first use purchaser, Springfield Marine Company will replace any seating product which proves to have a manufacturer's defect involving frame or substrate components in materials and workmanship under normal and proper usage.

Shark Seating branded products sold into the recreational boating market are backed by the following warranty terms:

HARDWARE - 3-Year Limited Warranty: Pedestals, Mounts & Accessories

For a period of 5 years from the date of sale to the first use purchaser, Springfield Marine Company will replace product which proves to have manufacturer's defect in materials and workmanship under normal and proper usage.

SEATING - 1-Year Limited Warranty: Upholstery, Cushions & Electrical Components

For a period of 1 year from the date of sale to the first use purchaser, Springfield Marine Company will replace any upholstered product which proves to have manufacturer's defect involving vinyl, fabric, leather or foam components in materials and workmanship under normal and proper usage.

SEATING - 3-Year Limited Warranty: Frame & Substrate

For a period of 5 years from the date of sale to the first use purchaser, Springfield Marine Company will replace any seating product which proves to have a manufacturer's defect involving frame or substrate components in materials and workmanship under normal and proper usage.

Shark Seating Product – Commercial & Government Markets

Shark Seating branded product sold into the commercial or government markets will vary depending on application - Please see your Shark Seating salesperson.

Limitation of Warranty

This warranty does not extend to consequential damages. Some states do not allow the exclusion or limitation of incidental or consequential damages, so the above limitation or exclusion may not apply to you. Springfield Marine Company is not liable for improper installation or improper use of the product or any failure or problems from lack of reasonable maintenance, racing activities, or commercial applications. These products are not designed or warranted for racing or high-performance use. Commercial use restrictions apply - contact for details. This warranty shall be considered void if the seat or any accessory/ equipment has been altered, modified, changed, or reworked, subjected to abuse, neglect, or accident, including abnormal use, and if the seat is installed in a manner that would subject the seat to abnormal use. The warranty shall be considered void if mixing Springfield Marine Company components with parts that are manufactured by any brand other than Springfield Marine Company. The foregoing is the only warranty or representation made, express or implied, and specifically, there is no warranty of merchantability and no warranty of fitness for a particular purpose.

To obtain service under the warranty, **a customer must notify our customer service department to obtain a return material authorization number** by sending an email to: warranty@springfieldgrp.com. Customers are responsible for paying return freight as well as the freight on a new order if making an exchange. Springfield Marine Company is not responsible for return packages that are lost or stolen in transit.

Authorized returns must contain the following information on the shipping label:

Ship to: Springfield Marine Co
Attn: Returns (place your RMA # here)
1093 N. Cynthia Drive
Nixa, MO 65714

PROPOSITION 65 CALIFORNIA



TABLE OF CONTENTS

Seating	4-33
FOLDING SEATS • STAND-UP SEATS • MOLDED SEATS • UPHOLSTERED SEATS • HELM SEATS	
KingPin™	35-42
PACKAGES • SEAT MOUNTS • POSTS • BASES • ACCESSORIES	
Taper-Lock™	43-47
PACKAGES • SEAT MOUNTS • POSTS • BASES • ACCESSORIES	
Plug-In™	48-53
PACKAGES • SEAT MOUNTS • POSTS • BASES • ACCESSORIES	
Thread-Lock™	54-56
PACKAGES • SEAT MOUNTS • POSTS • BASES • ACCESSORIES	
Spring-Lock™ & Clip-Lock	57-62
PACKAGES • SEAT MOUNTS • POSTS • BASES • ACCESSORIES	
2-3/8" Series	63-67
PEDESTAL PACKAGES • SLIDES & SWIVELS • PEDESTALS	
2-7/8" Series	68-75
PEDESTAL PACKAGES • SLIDES & SWIVELS • PEDESTALS	
4" Series	76-82
PEDESTAL PACKAGES • SLIDES & SWIVELS • PEDESTALS	
Shark Seating	83-87
SUSPENSION SEATING SYSTEMS	
Mounting Systems	88-94
MOUNTING SLIDES • MOUNTING SWIVELS • MOUNTING RAILS • MOUNTING POSTS	
Tables	95-105
TABLES PACKAGES • TABLE TOPS • MOUNTS • POSTS • BASES	
Ski Tow Pylons	106-109
SKI TOW PYLONS • MOUNTING BASES • MOUNTING RECEIVERS	
Ladders	110-111
BOARDING LADDERS • TELESCOPING LADDERS • SWIM LADDERS • DIVE LADDERS	
Accessories	112-122
BARBECUE GRILLS • ARMRESTS • DECK PLATES • MOTOR MOUNTS	

Seating Systems

KingPin™

Taper-Lock™

Plug-In™

Thread-Lock™

Spring-Lock™

2-3/8" Series

2-7/8" Series

4" Series

Shark Seating

Mounting Systems

Tables

Ski Tow Pylons

Ladders

Accessories

Part Number Index

POSTS • BASES

PEDESTALS



- **FOLDING SEATS**
- **STAND-UP SEATS**
- **MOLDED SEATS**
- **UPHOLSTERED SEATS**
- **HELM SEATS**

Seating

Enhance Your Boating Experience with Our Premium Seating Systems! **SPRINGFIELD Marine** understands the importance of comfort in marine seating, whether you're navigating rough waters or fishing in a quiet cove. Our extensive range of seating configurations and options ensure you find the perfect fit.

We prioritize quality, comfort, and strength, offering great value for your seating system. With a wide variety of chairs and an even larger selection of seating hardware, our combinations are unparalleled.

Choosing the right seating hardware to match your chair is crucial. Whether you're opting for one of our seating packages or creating your own combination, Springfield Marine has the right product to meet diverse needs.

For OEM production, we also offer custom seating and upholstery upon request.

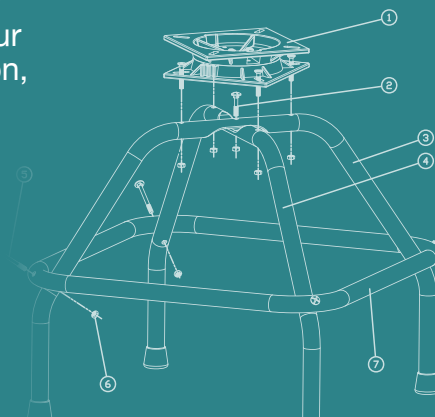
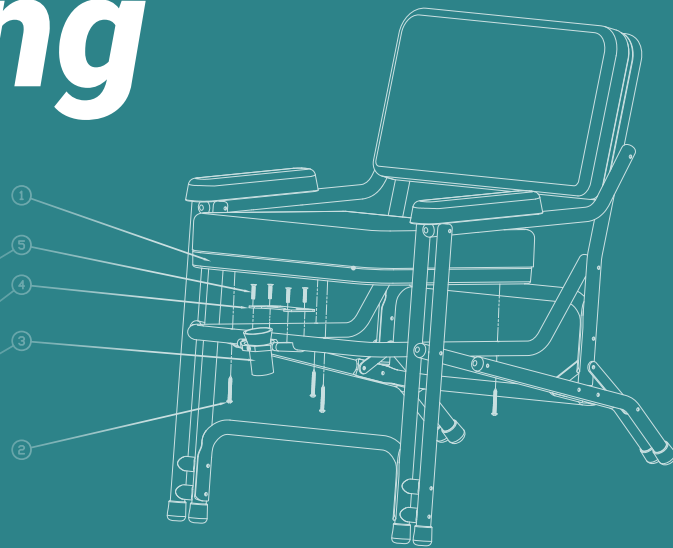



The ABYC H-31 Standards are rigorous guidelines established by the American Boat and Yacht Council to ensure the safety and reliability of seating systems used on boats. These standards specify the design, construction, and testing requirements to ensure that seating systems can withstand the stresses of regular use, high-speed operations, and rough waters, providing secure and stable seating for passengers. At Springfield Marine, we rigorously test our products to ensure they meet and exceed the ABYC H-31 Standards. This includes subjecting our seating systems to extensive stress testing, corrosion resistance evaluations, and durability assessments to confirm they can handle the demands of both leisure and commercial boating environments. By adhering to these standards, we ensure that our products provide the highest level of safety and performance for our customers.

DROP TEST:

9" above seat cushion.
400 lb bag with a 16" diameter dropped 2x.
Remains on seat for 5-min. with no material failure.



PULL TEST:

16" above seat cushion.
• 1st pull: 150 lbs for 5-min., at 30° with no more than 10° permanent deflection.
• 2nd pull: 235 lbs for 5-min., at 50° with no material failure.



ARM REST TEST:

200 lbs of pressure applied to 5° from vertical for 5-min. with no failure and must perform as intended.

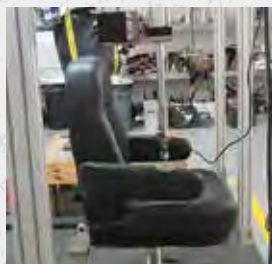

ROTATIONAL TORQUE TEST:

• AD (Driver) requires 150 lbs and mechanical interface
• AP (Passenger) requires 30 lbs



CLASSIFICATIONS



AD rating stands for "Accessory Designated" and refers to a classification within the ABYC standards for seating and pedestal systems. An AD rating indicates that the seat or pedestal is designed for use in specific, designated positions on a boat, typically those that are subject to moderate stress and forces during operation. Unlike the AP rating, the AD rating is more limited and tailored to areas that do not require the highest levels of impact resistance. This rating ensures that the seating system is appropriate for its intended location on the vessel, providing safety and durability where it is needed.



AP rating stands for "All Position" and is a classification within the ABYC standards related to seating and pedestals. This rating indicates that a seat or seating system is designed to be used in any position on a boat, including high-stress areas such as helm positions, where greater forces are encountered during operation. Products with an ABYC AP rating have been tested and proven to withstand the rigors of all positions on the boat, ensuring they provide safety and stability regardless of where they are installed.



"B" rating designates seats intended for use in areas of a boat that experience lower levels of stress and impact, such as those not typically exposed to rough conditions or high-speed operation. Seats with a "B" rating are designed to accommodate seated occupants during normal boat operation but are not intended for high-speed or offshore use where greater forces might be encountered. This rating helps manufacturers and consumers ensure that seating is appropriately matched to the intended use and conditions of the boat.

FISH PRO 1 HIGH-BACK MOSSY OAK®

FOLDING SEATS



IMAGE	PART NUMBER	DESCRIPTION	PACK QUANTITY
A	1041647	BREAK-UP® COUNTRY™	1 PACK
C	1041648	SHADOW GRASS® BLADES™	1 PACK
B	1041698	ELEMENTS AGUA® COASTAL SHORELINE™	1 PACK
D	1041697	ELEMENTS AGUA® SPINDRIFT™	1 PACK

Fish Pro 1 seat with licensed Mossy Oak® camo patterns.

- Universal mounting pattern: 5" x 5" and 5" x 12"
- Concealed pinch-proof center pivot point
- Channel designed for optional armrests (sold separately)
- Marine-grade vinyl is UV treated, mildew resistant, and water-resistant

FISH PRO 1

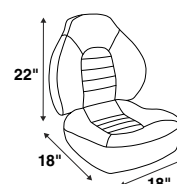

IMAGE	PART NUMBER	DESCRIPTION	PACK QUANTITY
A	1041606-1	FISH PRO 1, SEAT - WHITE	1 PACK
B	1041631-1	FISH PRO 1, SEAT - GRAY/BLUE	1 PACK
C	1041634-1	FISH PRO 1, SEAT - CHAR/GRAY	1 PACK
D	1041684-1	FISH PRO 1, SEAT - CHAR/TAN	1 PACK
E	1041636	FISH PRO MID BACK, FOLDING SEAT - WHITE	1 PACK
F	1041733	FISH PRO MID BACK, FOLDING SEAT - CHAR/GRAY	1 PACK

Premium upholstery and cushions are designed to provide maximum comfort and quality. Backrest is fitted with ergonomically molded cushions and extended sides for extra support. Durable injection molded shell with center pivot point allows seat to fold down flat.

- Weather resistant marine-grade Grandeur vinyl
- Concealed pinch-proof center pivot point

• Channel designed for optional armrests (sold separately, high-back only)

SUBSTRATE & FOAM FISH PRO 1



IMAGE	PART NUMBER	DESCRIPTION	PACK QUANTITY
A	1041600-SF1	FISH PRO 1 - SUBSTRATE & FOAM	1 PACK

Plastic injected substrate with support ribbing.

- Molded-in T-nuts
- Molded foam
- Concealed pinch-proof center pivot point
- Channel for optional armrests



BACK



BOTTOM

FISH PRO '24 HIGH-BACK FOLDING SEAT

IMAGE	PART NUMBER	DESCRIPTION	PACK QUANTITY
A	1041650	FISH PRO '24, SEAT - WHITE/CHARCOAL	1 PACK



Premium upholstery and cushions are designed to provide maximum comfort and quality. Backrest is fitted with ergonomically molded cushions and extended sides for extra support. A durable injection molded shell with a center pivot point allows seat to fold down flat.

- Weather-resistant marine-grade vinyl
- Universal mounting pattern: 5" x 5" and 5"x12"
- Channel for optional armrests
- Concealed pinch-proof center pivot point



FOLDING SEATS

PREMIUM FOLDING SEAT INCOGNITO EDITION

IMAGE	PART NUMBER	DESCRIPTION	PACK QUANTITY
A	1062585	PREMIUM FOLDING SEAT - INCOGNITO EDITION - CHARCOAL-WHITE	1 PACK



Incognito edition includes gray carbon fiber texture and white luxury vinyl upholstery. Rigid injection-molded frame with high-density foam padding.

- Keyhole accent in backrest
- Universal mounting pattern: 5" x 5" and 5" x 12"
- Heavy-duty pinchless hinges
- Marine-grade vinyl is UV treated, mildew-resistant, and water-resistant



Heavy-Duty Pinchless Hinge



PREMIUM WAVE

IMAGE	PART NUMBER	DESCRIPTION	PACK QUANTITY
A	1062031	PREMIUM FOLDING-GRAY w/BLUE-METEOR STRIPE	1 PACK
B	1062034	PREMIUM FOLDING - GRAY w/METEOR-CHAR STRIPE	1 PACK



Premium high-quality upholstery and cushions with rigid injection molded frame for maximum support and comfort. Durable strap with snap keeps seat closed when folded down.

- Wave accent
- Universal mounting patterns: 5" x 5" and 5" x 12"
- Pinchless hinges



Economy Pinchless Hinge



Folded Position

SKIPPER PREMIUM HIGH BACK

FOLDING SEATS



IMAGE	PART NUMBER	DESCRIPTION	PACK QUANTITY
A	1061063-B	SKIPPER PREM HB, FOLDING SEAT, CHAR-GRAY	1 PACK
B	1061069-B	SKIPPER PREM HB, FOLDING SEAT, BLUE-GRAY	1 PACK

Contour lumbar cushion cradles your back for maximum support. Designed for style, comfort and durability. Folds down easily.

- Injected plastic frame
- T-nuts installed into seat for better mounting durability
- Universal mounting pattern: 5" x 5"
- Sorrento / Heritage vinyl



Folded Position

SKIPPER PREMIUM, INCOGNITO EDITION



IMAGE	PART NUMBER	DESCRIPTION	PACK QUANTITY
A	1061060-01	SKIPPER PREM., LB INCOGNITO ED. CHAR-WHITE	1 PACK

Incognito edition features gray carbon fiber texture and white luxury vinyl upholstery. Durable injection-molded black plastic frame with interlocking hinge design for added structural integrity.

- Universal mounting pattern: 5" x 5"
- Marine-grade vinyl is UV treated, mildew-resistant, and water-resistant

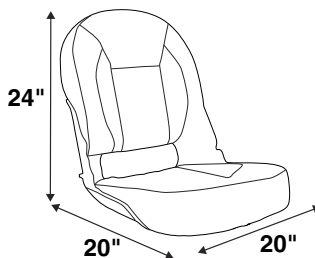

Folded Position

SKIPPER PREMIUM LOW-BACK



IMAGE	PART NUMBER	DESCRIPTION	PACK QUANTITY
A	1061077-1	SKIPPER PREM LB, FOLDING SEAT - GRAY-BLACK	1 PACK
B	1061079-1	SKIPPER PREM LB, FOLDING SEAT - GRAY-BLUE	1 PACK

Injection molded seats with interlocking hinge for greater structural support. Extra wide seat with high-quality marine-grade vinyl for all day comfort.

- Black plastic frame
- Folds down easily
- T-nuts installed into seat for better mounting durability
- Universal mounting pattern: 5" x 5"
- Grandeur / Imperial vinyl



Folded Position

SKIPPER DELUXE



Folded Position

IMAGE	PART NUMBER	DESCRIPTION	PACK QUANTITY
A	1061057	SKIPPER DELUXE, GRAY w/CHAR-GRAY CUSHIONS	1 PACK
B	1061072	SKIPPER OEM DELUXE w/CHAR-GRAY CUSHIONS	1 PACK

Injection molded seats with interlocking hinge for greater structural support. Extra wide seat with high-quality marine-grade vinyl for all day comfort.

- Folds down easily
- T-nuts installed into seat for better mounting durability
- Universal mounting pattern: 5" x 5"
- Snap-on cushion



FOLDING SEATS

SKIPPER STANDARD

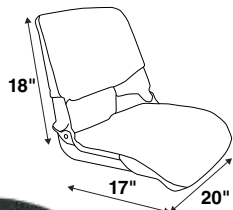

IMAGE	PART NUMBER	DESCRIPTION	PACK QUANTITY
A	1061016	SKIPPER, WHITE SHELL w/WHITE-BLUE CUSHION	1 PACK
B	1061017	SKIPPER, GRAY SHELL w/GRAY-CHAR CUSHION	1 PACK
C	1061018	SKIPPER, GRAY SHELL w/GRAY-RED CUSHION	1 PACK
D	1061019	SKIPPER, GRAY SHELL w/GRAY-BLU CUSHION	1 PACK
E	1061025	SKIPPER, WHITE SHELL w/WHITE CUSHION	1 PACK

Injection molded seats with interlocking hinge for greater structural support. Extra wide seat with high-quality upholstery for all day comfort.

- Universal mounting pattern: 5" x 5" and 5" x 12"
- Snap on cushions



SKIPPER CAMO MOSSY OAK®

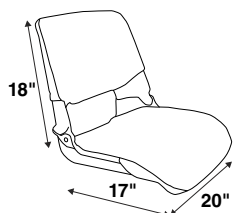

IMAGE	PART NUMBER	DESCRIPTION	PACK QUANTITY
A	1061020	SKIPPER, BLACK SHELL w/MOSSY OAK™ CAMO*	1 PACK

Injection molded seats with interlocking hinge for greater structural support. Extra wide seat with premium high-quality marine-grade camouflage water-resistant canvas.

- Universal mounting pattern: 5" x 5" and 5" x 12"
- Black plastic shell



Folded Position

* BREAK UP COUNTRY / COUNTRY DNA

SKIPPER SHELLS

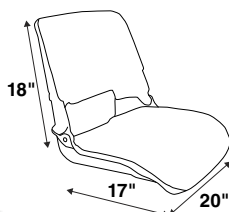

IMAGE	PART NUMBER	DESCRIPTION	PACK QUANTITY
A	1061015-S	SKIPPER, FOLD DOWN SHELL - GRAY	1 PACK
B	1061015-SB	SKIPPER, FOLD DOWN SHELL - BLACK	1 PACK
C	1061015-SW	SKIPPER, FOLD DOWN SHELL - WHITE	1 PACK
A	1061015-M	SKIPPER, FOLD DOWN SHELL - GRAY	10 PACK BULK
B	1061015-MB	SKIPPER, FOLD DOWN SHELL - BLACK	10 PACK BULK
C	1061015-MW	SKIPPER, FOLD DOWN SHELL - WHITE	10 PACK BULK
D	1061015-MS	SKIPPER, FOLD DOWN SHELL - SAND	10 PACK BULK

Injection molded seats with interlocking hinge for greater structural support.

- Universal mounting pattern: 5" x 5" and 5" x 12"
- T-Nuts



Folded Position

TRAVELER MULTI-COLOR

FOLDING SEATS



IMAGE	PART NUMBER	DESCRIPTION	PACK QUANTITY
A	1061121-C	TRAVELER GRAY SHELL w/BLUE-GRAY CUSHION	2 PACK
B	1061123-C	TRAVELER GRAY SHELL w/CHAR-GRAY CUSHION	2 PACK
C	1061115-C	TRAVELER GRAY SHELL w/BLUE CUSHION	2 PACK

Super strong copolymer frame with extra wide contoured seat and curved back.
 • Durable strap holds seat closed when folded down
 • Universal mounting pattern: 5.25" x 5.25"



TRAVELER STANDARD



IMAGE	PART NUMBER	DESCRIPTION	PACK QUANTITY
A	1061100-C	TRAVELER, GRAY SHELL w/GRAY CUSHION	2 PACK
B	1061103-C	TRAVELER, BLACK SHELL w/BLACK CUSHION	2 PACK
C	1061104-C	TRAVELER, WHITE SHELL w/WHITE CUSHION	2 PACK
D	1061105-C	TRAVELER, GREEN SHELL w/GREEN CUSHION	2 PACK
E	1061112-C	TRAVELER, GRAY SHELL w/BLUE CUSHION	2 PACK
F	1061113-C	TRAVELER, GRAY SHELL w/CHAR CUSHION	2 PACK
G	1061114-C	TRAVELER, GRAY SHELL w/RED CUSHION	2 PACK



TRAVELER CAMO



IMAGE	PART NUMBER	DESCRIPTION	PACK QUANTITY
A	1061106-C	TRAVELER, GRN SHELL w/MOSSY OAK™ CAMO*	2 PACK

Super strong copolymer frame with extra wide contoured seat and curved back.
 • Durable strap holds seat closed when folded down
 • Universal mounting pattern: 5.25" x 5.25"
 • Premium high-quality marine-grade camouflage water-resistant canvas

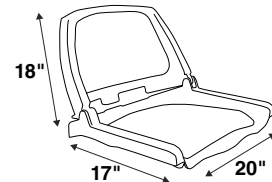

* BREAK UP COUNTRY / COUNTRY DNA

TRAVELER SHELLS

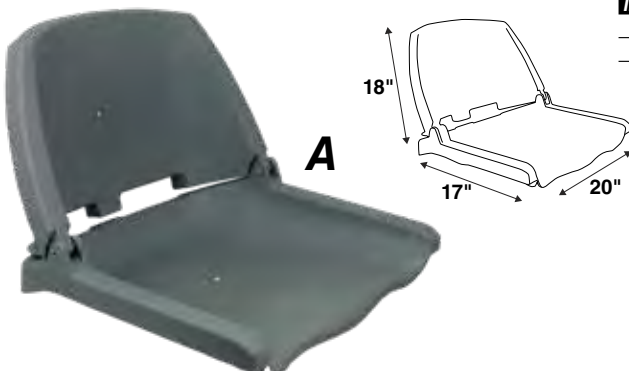
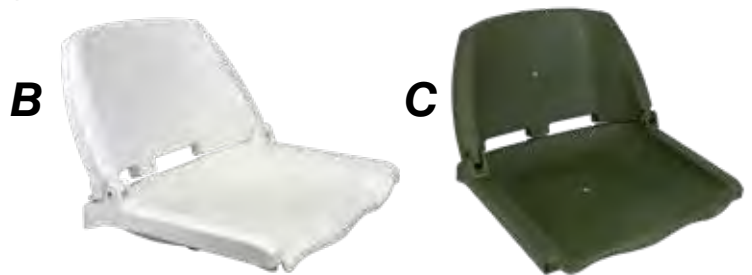

IMAGE	PART NUMBER	DESCRIPTION	PACK QUANTITY
A	1061100-S	TRAVELER FOLD DOWN SHELL - GRAY	2 PACK
B	1061104-S	TRAVELER FOLD DOWN SHELL - WHITE	2 PACK
C	1061105-S	TRAVELER FOLD DOWN SHELL - GREEN	2 PACK



OEM FOLDING



IMAGE	PART NUMBER	DESCRIPTION	PACK QUANTITY
A	1062583	OEM SERIES, FOLDING SEAT - CHARCOAL-TAN	1 PACK
B	1062683	OEM MEDIUM SERIES, FOLDING SEAT - CHAR-TAN	1 PACK

Premium high-quality upholstery and cushions with rigid injection molded frame.

- Folds down easily
- Heavy-duty pinchless hinges
- Weather-resistant marine-grade vinyl
- Universal mounting Pattern: 5" x 5" and 5" x 12"



Heavy-Duty Pinchless Hinge



Folded Position

FOLDING SEATS

HIGH-BACK PREMIUM PINCHLESS



IMAGE	PART NUMBER	DESCRIPTION	PACK QUANTITY
A	1062025-01	PREMIUM PINCHLESS SEAT - CHARCOAL-GRAY	1 PACK

Premium high-quality upholstery and cushions with rigid injection molded frame.

- Folds down easily
- Heavy-duty pinchless hinges
- Weather-resistant marine-grade vinyl
- Universal mounting Pattern: 5" x 5" and 5" x 12"
- Double Stitch



Heavy-Duty Pinchless Hinge



Folded Position

SPORT FOLDING



IMAGE	PART NUMBER	DESCRIPTION	PACK QUANTITY
A	1040513	SPORT FOLDING SEAT, BLUE-GRAY	1 PACK
B	1040543	SPORT FOLDING SEAT, GRAY-CHARCOAL	1 PACK

Premium high-quality upholstery and cushions with rigid injection molded frame.

- Folds down easily
- Heavy-duty pinchless hinges
- Weather-resistant marine-grade vinyl
- Universal mounting Pattern: 5" x 5" and 5" x 12"
- Double Stitch



B



Heavy-Duty Pinchless Hinge



Folded Position

HIGH-BACK MULTI-COLOR

FOLDING SEATS

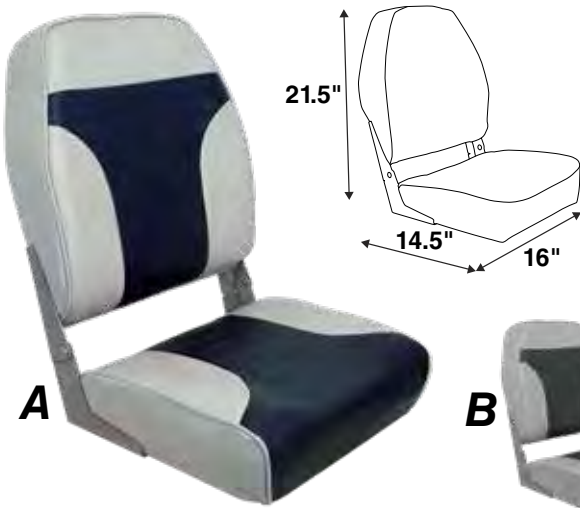

IMAGE	PART NUMBER	DESCRIPTION	PACK QUANTITY
A	1040661	HIGH-BACK ECONOMY FOLDING SEAT - GRAY/BLUE	1 PACK
B	1040663	HIGH-BACK ECONOMY FOLDING SEAT - GRAY/CHAR	1 PACK
C	1040665	HIGH-BACK ECONOMY FOLDING SEAT - GRAY/RED	1 PACK
D	1040667	HIGH-BACK ECONOMY FOLDING SEAT - WHT/BLUE	1 PACK
E	1040668	HIGH-BACK ECONOMY FOLDING SEAT - SAND-BRN	1 PACK

- Strap-on back for secure seat fastening
- Folds down easily
- Pinchless hinges
- Weather-resistant marine-grade vinyl
- Universal mounting pattern: 5" x 5"



HIGH-BACK STANDARD



IMAGE	PART NUMBER	DESCRIPTION	PACK QUANTITY
A	1040649	HIGH-BACK ECONOMY FOLDING SEAT - WHITE	1 PACK
B	1040643	HIGH-BACK ECONOMY FOLDING SEAT - GRAY	1 PACK

- Strap-on back for secure seat fastening
- Folds down easily
- Weather-resistant marine-grade vinyl
- Pinchless hinges
- Universal mounting pattern: 5" x 5"

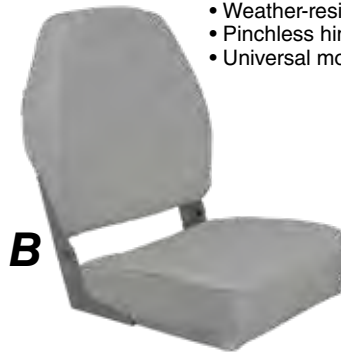

HIGH-BACK CAMO



IMAGE	PART NUMBER	DESCRIPTION	PACK QUANTITY
A	1040646	HIGH-BACK FOLDING - MOSSY OAK™ CAMO*	1 PACK

- Strap-on back for secure seat fastening
- Folds down easily
- High-quality marine-grade camouflage water-resistant canvas
- Pinchless hinges
- Universal mounting pattern: 5" x 5"



* BREAK UP COUNTRY / COUNTRY DNA

Economy Pinchless Hinge

ECONOMY MULTI-COLOR



IMAGE	PART NUMBER	DESCRIPTION	PACK QUANTITY
A	1040651	ECONOMY FOLDING SEAT - GRAY-BLUE	1 PACK
B	1040653	ECONOMY FOLDING SEAT - GRAY-CHARCOAL	1 PACK
C	1040655	ECONOMY FOLDING SEAT - GRAY-RED	1 PACK

Comfortable cushioned seat to support your backside. Strap with snap to keep seat secure when folded down. Rigid injection molded frame.

- Folds down easily
- Heavy-duty powder-coated hinges
- Universal mounting pattern: 5" x 5"



Economy Pinchless Hinge

FOLDING SEATS

ECONOMY STANDARD



IMAGE	PART NUMBER	DESCRIPTION	PACK QUANTITY
A	1040621	ECONOMY FOLDING SEAT - BLUE	1 PACK
B	1040622	ECONOMY FOLDING SEAT - GREEN	1 PACK
C	1040623	ECONOMY FOLDING SEAT - GRAY	1 PACK
D	1040624	ECONOMY FOLDING SEAT - CHARCOAL	1 PACK
E	1040625	ECONOMY FOLDING SEAT - RED	1 PACK
F	1040628	ECONOMY FOLDING SEAT - TAN	1 PACK
G	1040629	ECONOMY FOLDING SEAT - WHITE	1 PACK



Economy Pinchless Hinge



ECONOMY CAMO



IMAGE	PART NUMBER	DESCRIPTION	PACK QUANTITY
A	1040626	ECONOMY CAMO - MOSSY OAK™ CAMO*	1 PACK

Comfortable cushioned seat to support your backside. Strap with snap to keep seat secure when folded down. Rigid injection molded frame.

- Folds down easily
- Black e-coated hinges
- Universal mounting pattern: 5" x 5"



Economy Pinchless Hinge



Folded Position

* BREAK UP COUNTRY / COUNTRY DNA

XXL FOLDING SEAT

FOLDING SEATS

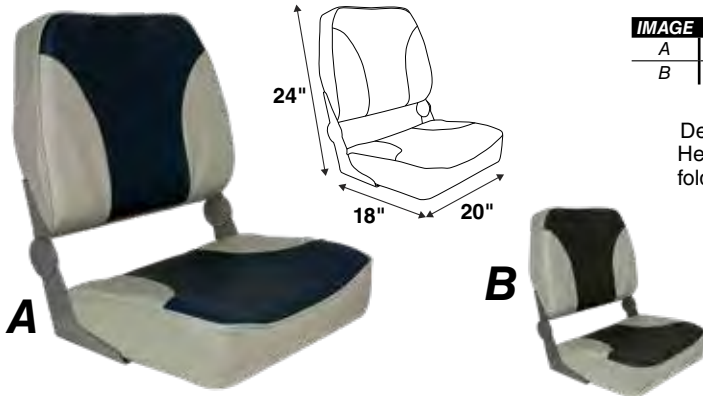

IMAGE	PART NUMBER	DESCRIPTION	PACK QUANTITY
A	1040691	XXL FOLDING SEAT - GRAY-BLUE	1 PACK
B	1040693	XXL FOLDING SEAT - CHARCOAL-GRAY	1 PACK

Designed for the plus-size body frame. Marine-grade vinyl with plush foam padding. Heavy-duty powder-coated hinges. Strap with snap to keep seat secure when folded down.

- Folds down easily
- Extra-wide seat
- Heavy-duty pinchless hinges
- Universal mounting pattern: 5" x 5"
- Strap on back for secure seat fastening



Heavy-Duty Pinchless Hinge

DOUBLE WIDE SEAT FOLDING



IMAGE	PART NUMBER	DESCRIPTION	PACK QUANTITY
A	1042039	DOUBLE WIDE FOLDING SEAT - WHITE	1 PACK

Double wide seat. Marine-grade vinyl with plush foam padding. Heavy-duty powder-coated hinges

- Folds down easily
- Heavy-duty pinchless hinges
- Quilted stitch pattern



Heavy-Duty Pinchless Hinge

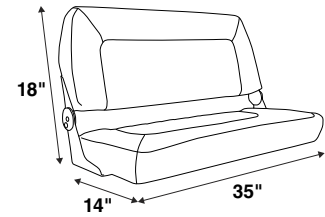

FOLDING SEAT PACKAGE



IMAGE	PART NUMBER	DESCRIPTION	PACK QUANTITY
A	1061100	TRAVELER CHAIR PACKAGE w/CUSHIONS	1 PACK
B	1001003	SKIPPER CHAIR PACKAGE w/CUSHIONS	1 PACK

Traveler chair package includes:

- Traveler fold down seat with cushions
- 15" fixed-height pedestal with 9" floor base*
- Anodized finish
- KingPin™ seat mount with e-coat finish, rotates 360°



Traveler Folding Seat



KingPin™ Seat Mount (B)



Explorer Non-locking Pedestal

Skipper chair package includes:

- Skipper injected molded seat with cushions
- 15" fixed-height pedestal with 9" floor base*
- Anodized finish
- Locking Trac-Lock™ swivel, rotates 360°



Skipper Folding Seat



Trac-Lock™ Locking Swivel (AD)



Second Generation Locking Pedestal

* Dimensions are from deck to top of pedestal and may vary slightly.

ON-DECK RATCHET SEAT

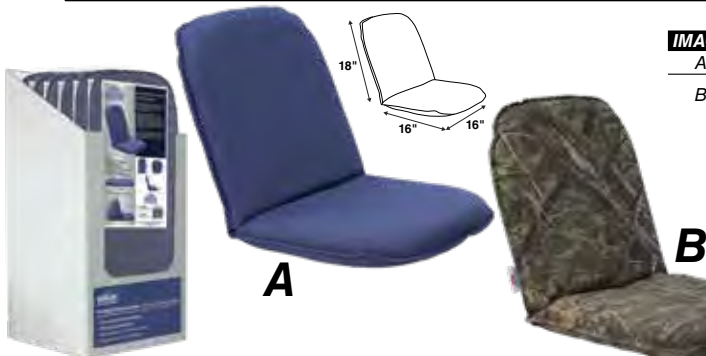

IMAGE	PART NUMBER	DESCRIPTION	PACK QUANTITY
A	1081060	ON-DECK RATCHET SEAT - BLUE	6 PACK
B	1081060-01	ON-DECK RATCHET SEAT MOSSY OAK™ COUNTRY DNA	6 PACK

Whether you're out on the water or hitting the open road, the on-deck ratchet seat travels anywhere you need a quick seat: fishing, pontoon/leisure boat, live game, concert, beach, or any other place you might need a comfortable travel seat.

- Ratchets up into an upright sitting position
- Folds down flat for storage
- Durable frame



Folds Flat for Easy Storage



Ratcheting Hinge System

MAKING BOATING BETTER

PRO CASTING SEATS



IMAGE	PART NUMBER	DESCRIPTION	PACK QUANTITY
A	1040235-01	PRO CASTING SEAT - MED GRAY-LIGHT GRAY	1 PACK
B	1040235-02	PRO CASTING SEAT - MED GRAY/LT GRAY-BURGUNDY	1 PACK

Cast like a pro! Premium marine-grade vinyl is UV treated, mildew-resistant, and water-resistant.

- Universal mounting pattern: 5.5" x 5.5"
- Use with Springfield® stand-up pedestals
- Premium padding
- Easily stowable

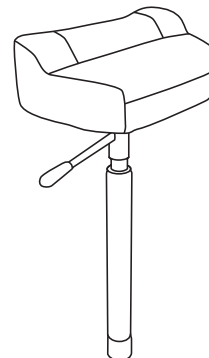
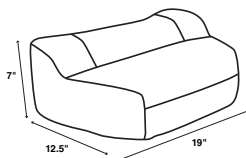

CASTING SEATS

PRO CASTING STATIONS

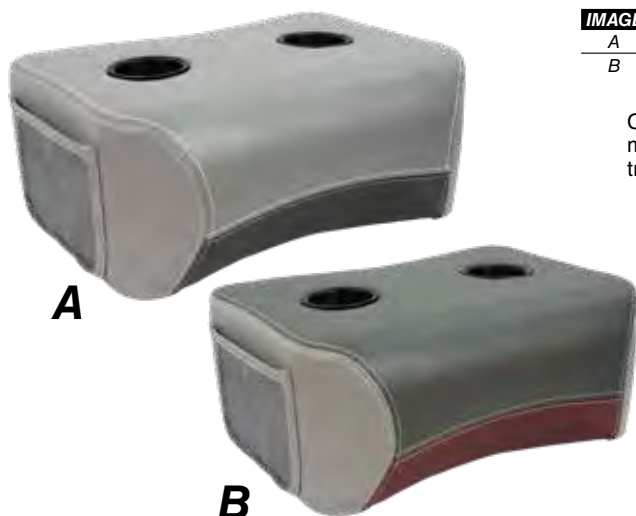
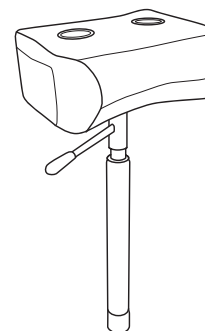
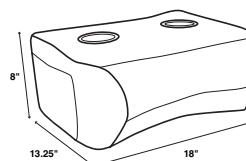

IMAGE	PART NUMBER	DESCRIPTION	PACK QUANTITY
A	1040236-01	PRO CASTING STATION - LT GRAY-MED GRAY	1 PACK
B	1040236-02	PRO CASTING STN - LT GRAY-MED GRAY-BURGUNDY	1 PACK

Cast like a pro! Casting stations include drink holders with drains and side mesh pockets for tools and accessories. Premium marine-grade vinyl is UV treated, mildew-resistant, and water-resistant.

- Universal mounting pattern: 5.5" x 5.5"
- Use with Springfield® stand-up pedestals
- Premium padding
- Easily stowable
- Mesh storage pocket on both sides



FOLDING CASTING SEAT

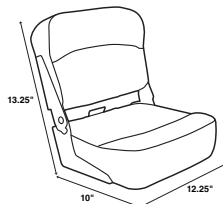

IMAGE	PART NUMBER	DESCRIPTION	PACK QUANTITY
A	1040205	FOLDING CASTING SEAT - MEDIUM GRAY	1 PACK

Folding casting seat that offers support for your back and legs while fishing.

- Mount to any stand-up seat pedestal
- Approx. 12"W x 13"H x 11"D
- Universal mounting pattern: 5" x 5"
- Pinchless hinge
- Mesh storage pocket on seat back



PRO STAND-UP

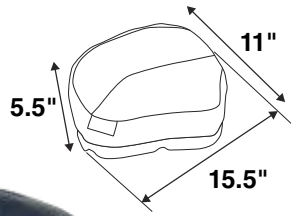

IMAGE	PART NUMBER	DESCRIPTION	PACK QUANTITY
A	1040211	PRO STAND-UP - BLUE	1 PACK
B	1040212	PRO STAND-UP - BLACK	1 PACK
C	1040213	PRO STAND-UP - GRAY	1 PACK
D	1040214	PRO STAND-UP - TAN	1 PACK
E	1040215	PRO STAND-UP - RED	1 PACK
F	1040216	PRO STAND-UP - WHITE	1 PACK
G	1040217	PRO STAND-UP - MOSSY OAK® CAMO*	1 PACK

Pro stand up seats have a contoured, plastic injected, fully-capped frame for added support and comfort. Heavy-duty marine-grade vinyl with embossed stitching over plush foam padding.

- Universal mounting pattern: 5.5" x 5.5"

MOSSY OAK
* DUCK BLIND/COUNTRY DNA

ECONOMY STAND-UP

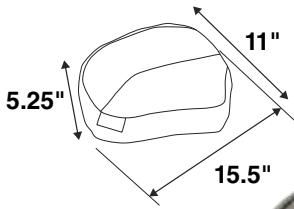

IMAGE	PART NUMBER	DESCRIPTION	PACK QUANTITY
A	1040213-NS	STAND-UP SEAT, ECONOMY - GRAY	1 PACK
B	1040216-NS	STAND-UP SEAT, ECONOMY - WHITE	1 PACK
C	1040212-NS	STAND-UP SEAT, ECONOMY - BLACK	1 PACK

Polyboard frame with mounting board. Marine-grade vinyl over plush foam padding.

- Universal mounting pattern: 5.5" x 5.5"

CONTROL POST

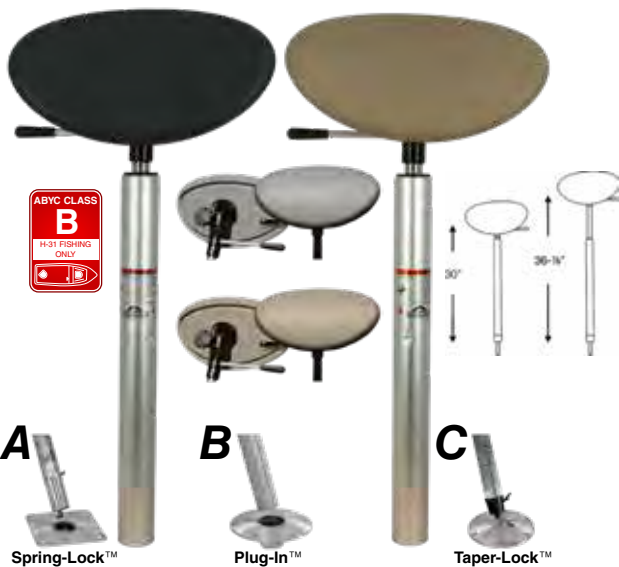

IMAGE	PART NUMBER	DESCRIPTION	PACK QUANTITY
A	1040350-SL	SPRING-LOCK™ CONTROL POST, CHAR-GRAY SEAT	1 PACK
A	1040351-SL	SPRING-LOCK™ CONTROL POST, MICA TAN SEAT	1 PACK
B	1040352-PIC	PLUG-IN™ CONTROL POST, CHAR-GRAY SEAT	1 PACK
B	1040352-PIM	PLUG-IN™ CONTROL POST, MICA TAN SEAT	1 PACK
C	1040353-TLC	TAPER-LOCK™ CONTROL POST, CHAR-GRAY SEAT	1 PACK
C	1040353-TLM	TAPER-LOCK™ CONTROL POST, MICA TAN SEAT	1 PACK
D	1040355-KPC	KINGPIN™ CNTRL POST, CHAR-GRAY, THREADED	1 PACK
D	1040355-KPM	KINGPIN™ CNTRL POST, MICA TAN, THREADED	1 PACK
E	1040357-KPC	KINGPIN™ CNTRL POST, CHAR-GRAY, STANDARD	1 PACK
E	1040357-KPM	KINGPIN™ CNTRL POST, MICA TAN, STANDARD	1 PACK

From a completely flat position to 90° upright, the control post adjusts in every direction for complete comfort during even the longest days on the water.



MAKING BOATING BETTER

ECONOMY

IMAGE	PART NUMBER	DESCRIPTION	PACK QUANTITY
A	1042015-01	ECON COVER, LOW-BACK SEAT - BLACK - SML	1 PACK
B	1042015-02	ECON COVER, HIGH-BACK SEAT - BLACK - MED	1 PACK
C	1042015-03	ECON COVER, BUCKET SEAT - BLACK - LARGE	1 PACK
-	1042015-04	ECON COVER, CASTING SEAT - BLACK - EX SML	1 PACK

- Protect your seats from the elements while adding life to your vinyl.
- 2-layer, outer nylon material & inner water-resistant liner
 - UV stable
 - Folds up into a small mesh drawstring carrying bag
 - Lightweight, for stow only, not meant for trailering

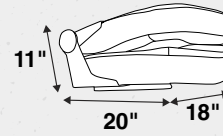
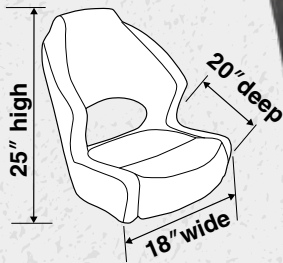
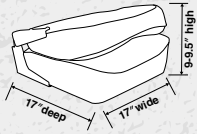

PREMIUM

IMAGE	PART NUMBER	DESCRIPTION	PACK QUANTITY
A	1042016-01	PREM COVER, LOW-BACK SEAT - SMALL	1 PACK
B	1042016-02	PREM COVER, HIGH-BACK SEAT - MED	1 PACK
C	1042016-03	PREM COVER, BUCKET SEAT - LARGE	1 PACK

- Protect your seats from the elements while adding life to your vinyl.
- Water-resistant 600D performance solution-dyed polyester
 - UV stable
 - Durable and easy to clean



DECK CHAIRS

DECK CHAIR PREMIUM

IMAGE	PART NUMBER	DESCRIPTION	PACK QUANTITY
A	1080021-SS	DECK FOLDING CHAIR - STAINLESS STEEL TUBING	1 PACK
B	1080125-CR	PREMIUM DECK CHAIR	1 PACK
C	1080129-SS	MOSSY OAK® ELEMENTS AGUA® SHORELINE™	1 PACK

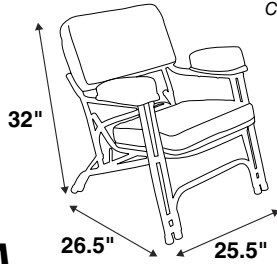

Dual 1" stainless steel tubing, eight-legged frame with rubber capped feet for extra stability. Folds down easily for transportation.

- Durable plastic substrate
- Stainless steel tubing
- Weather-resistant marine-grade vinyl
- Durable plastic substrate
- Aluminum tubing
- Premium padded foam armrests
- Cup holder in armrest
- Extra thick padding



DECK CHAIR CLASSIC

IMAGE	PART NUMBER	DESCRIPTION	PACK QUANTITY
A	1080021	DECK FOLDING CHAIR - STANDARD	1 PACK
B	1080021-EMB	DECK FOLDING CHAIR - EMBROIDERED SAIL FISH	1 PACK
C	1080022	DECK FOLDING CHAIR - WITH GIMBAL	1 PACK
D	1080126	MOSSY OAK® SHADOW GRASS® BLADES™	1 PACK
	2100300	BOLT-ON GIMBAL	1 PACK
	2100157	REPAIR KIT	1 PACK

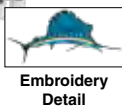
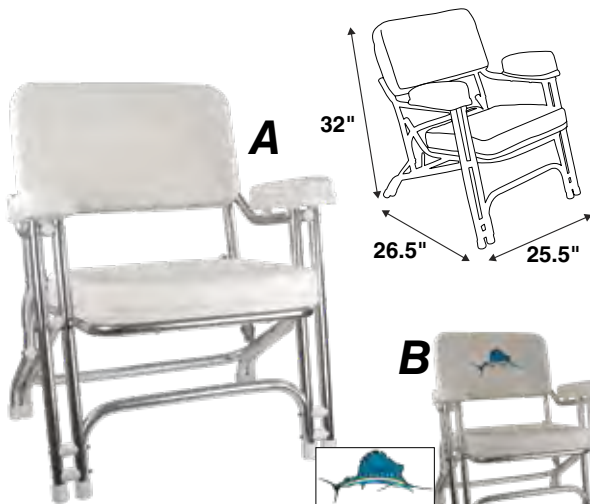

Take these chairs wherever you go. Perfect for picnics, decks, docks or the action station for the fighting fisherman. Folds down easily for transportation.

- Durable plastic substrate
- Heavy-duty aluminum tubing
- Weather-resistant marine-grade vinyl

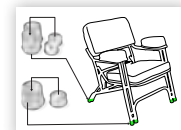

Repair Kit 2100157 fits any deck chair (available separate)



Bolt-on Gimbal 2100300 fits any deck chair (available separate)

DECK CHAIR

IMAGE	PART NUMBER	DESCRIPTION	PACK QUANTITY
A	1080121	DECK FOLDING CHAIR - EUROPEAN STYLE	1 PACK
B	1080120	HIGH-BACK DECK FOLDING CHAIR - BLUE	1 PACK



Folds flat, locking bar keeps legs locked in place for extra stability. Can be used with or without cushions. Includes back and seat cushions.

- (A)
- Cushions are removable
 - Weather-resistant marine-grade vinyl
 - Plastic armrests
 - Aluminum frame

- (B)
- Blue canvas cover
 - Padded headrest and leg rest
 - Wood arm rest
 - Aluminum frame

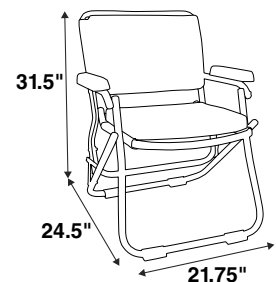

FIRST MATE MOLDED

IMAGE	PART NUMBER	DESCRIPTION	PACK QUANTITY
A	1061014-S	FIRST MATE, MOLDED SEAT - GRAY	1 PACK
B	1061014-SG	FIRST MATE, MOLDED SEAT - GREEN	1 PACK
C	1061014-M	FIRST MATE, MOLDED SEAT - MULTI-PACK GRAY	10 PACK

First mate molded seats are one piece molded shells, made from PP plastic. Durable and lightweight, for years of carefree use.

- Durable plastic
- Universal mounting pattern: 5" x 5"
- Stack for retail presentation

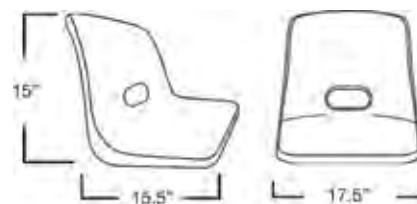
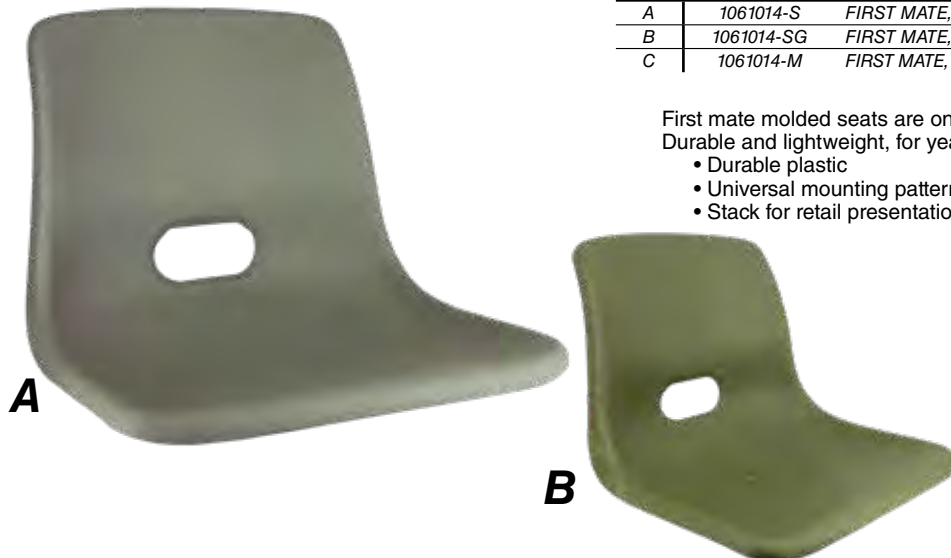

Seat Dimensions

MOLDED SEATS

ROTATIONAL MOLDED

One piece white molded shell, made from LLDPE plastic with UV inhibitors for years of carefree use. Available in a variety of shapes and styles.

For proper support use mounting plate #3100207 or any Trac-Lock™ slide (sold separately).

Seat cushions are available in off white for each seat style. Cushions are made from plush foam padding covered with marine-grade vinyl. Designed with heat seal channels and quick-dry construction. Cushions snap easily to the seat.



Cushions



Mounting Plate



MOLD #	#1	#2	#3	#4	#13	#16
1 PACK	NEW PORT	COMMODORE	YACHTSMAN II	SEAFARER	BLUEWATER	ADMIRAL
SEAT SHELL ONLY	1060002-S	1060206-S	1060410-S	1060610-S	1061205-S	1061405-S
SEAT SHELL w/CUSHION & MOUNTING PLATE	1060004-C	1060204-C	1060407-C	1060605-C	1061201-C	-
SEAT SHELL w/MOUNTING PLATE	1060004	1060204	1060407	1060605	1061201	1061403
10 PACK BULK OEM	1060002-M	1060206-M	1060410-M	1060610-M	1061205-M	1061405-M
WHITE CUSHIONS	1045014	1045020	1045028	1045014	1045035	1045036
DIMENSIONS	18"Hx20"Wx16"D	19"Hx20"Wx16"D	17"Hx21.5"Wx16"D	17"Hx16"Wx14"D	18"Hx20"Wx16"D	17"Hx19"Wx16"D

NEWPORT PACKAGE

MOLDED SEATS



IMAGE	PART NUMBER	DESCRIPTION	PACK QUANTITY
A	1060100	NEWPORT ADJUSTABLE PACKAGE	1 PACK
B	1060100-L	NEWPORT CHAIR PKG, 15" PED w/LOCKING SLIDE	1 PACK

Package Includes:

- Newport molded seat with off white cushions
- 2-3/8" locking Trac-Lock™ swivel, rotates 360°
- Manual adjustable pedestal with 9" floor base, satin finish

Dimensions are from deck to top of swivel, and may vary slightly.



COMMODORE PACKAGE



IMAGE	PART NUMBER	DESCRIPTION	PACK QUANTITY
A	1000202	COMMODORE ADJUSTABLE PACKAGE	1 PACK
B	1000205-L	COMMODORE PKG, 15" FIXED-HEIGHT PEDESTAL	1 PACK

A. Package Includes:

- Commodore molded seat with off white cushions
- 2-3/8" locking Trac-Lock™ swivel, rotates 360°
- Manual adjustable pedestal with 9" floor base, satin finish
- Extends from 13" to 16"

B. Package Includes:

- Commodore molded seat with off white cushions
- 2-7/8" locking Trac-Lock™ swivel, rotates 360°
- Slide travels 5-1/4" fore and aft
- Fixed height 15" pedestal with 9" round floor base, anodized finish

Dimensions are from deck to top of swivel, and may vary slightly.



COMMODORE PACKAGE MOSSY OAK®

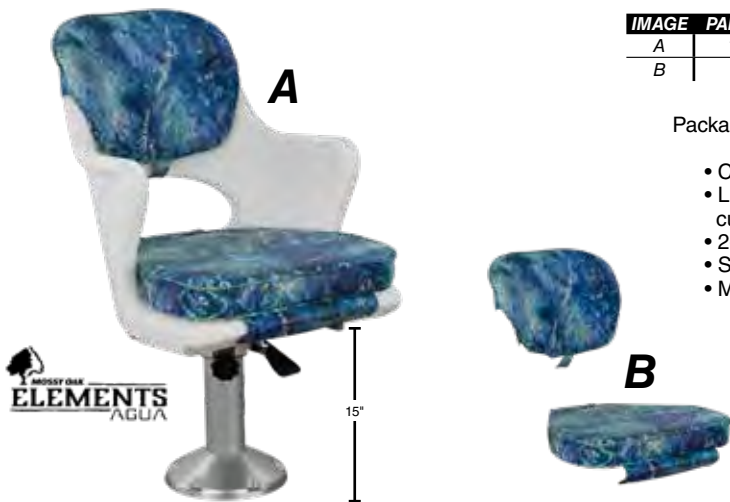

IMAGE	PART NUMBER	DESCRIPTION	PACK QUANTITY
A	1000208-L	ELEMENTS AGUA® COASTAL SHORELINE™	1 PACK
B	1045018	CUSHIONS ONLY	1 PACK

Package Includes:

- Commodore rotational-molded seat (1060206-S)
- Licensed Mossy Oak® Elements Agua® Coastal Shoreline™ printed cushions (1045018)
- 2-7/8" locking Trac-Lock™ III slide & swivel mount (3100521-L1)
- Second generation 15" fixed-height 2-7/8" pedestal (1240015-SAL)
- Marine-grade vinyl is UV treated, mildew-resistant, and water-resistant



YACHTSMAN PREMIUM SEAT



IMAGE	PART NUMBER	DESCRIPTION	PACK QUANTITY
A	1060425-C	YACHTSMAN PREM SEAT - WHITE-GRAY CUSHIONS	1 PACK
B	1045029	YACHTSMAN PREM CUSHIONS ONLY - WHITE-GRAY	1 PACK
C	1001416-L	YACHTSMAN PEDESTAL PKG - WHITE-GRAY	1 PACK

The one-piece shell of the Yachtsman is made from LLDPE plastic with UV inhibitors for years of carefree use. Cushions are made from plush foam padding covered with marine-grade vinyl. Designed with heat seal channels and quick dry construction.

- Available in a variety of shapes and styles
- Snap-on cushions with rear pockets



MOLDED SEATS

YACHTSMAN PACKAGE



IMAGE	PART NUMBER	DESCRIPTION	PACK QUANTITY
A	1001414-L	YACHTSMAN FIXED-HEIGHT PACKAGE	1 PACK
B	1001414	YACHTSMAN FIXED-HEIGHT	1 PACK

Package Includes:

- Yachtsman molded seat with off white cushions
- 2-7/8" locking Trac-Lock™ swivel, rotates 360°
- Slide travels 5-1/4" fore and aft
- Fixed height pedestal with 9" round floor base, anodized finish

Dimensions are from deck to top of swivel, and may vary slightly.



YACHTSMAN PACKAGE MOSSY OAK®



IMAGE	PART NUMBER	DESCRIPTION	PACK QUANTITY
A	1001415-L	ELEMENTS AGUA® SPINDRIFT™ PATTERN	1 PACK
B	1045025	CUSHIONS ONLY	1 PACK

Package Includes:

- Yachtsman II rotational-molded seat
- Licensed Mossy Oak® Elements Agua® Spindrift™ printed cushions (1045025)
- 2-7/8" locking Trac-Lock™ III slide & swivel mount
- Second generation fixed-height 2-7/8" pedestal
- Marine-grade vinyl is UV treated, mildew-resistant, and water-resistant



BLUEWATER PACKAGE



IMAGE	PART NUMBER	DESCRIPTION	PACK QUANTITY
A	1001204-L	BLUEWATER ADJUSTABLE PACKAGE	1 PACK

Package Includes:

- Bluewater molded seat with off white cushions
- 2-3/8" locking Trac-Lock™ air-ride slide & swivel, rotates 360°
- Slide travels 5-1/4" fore and aft
- Air-powered adjustable mainstay with 9" round base, anodized finish

One of our largest molded seats at 18"H x 20"W x 16"D! Cushions are made with plush foam padding covered in marine-grade vinyl and snap easily onto seat. Designed for the plus-size body frame.

Dimensions are from deck to top of swivel, and may vary slightly.

SEAFARER PACKAGE



IMAGE	PART NUMBER	DESCRIPTION	PACK QUANTITY
A	1000605-L	SEAFARER FIXED-HEIGHT PACKAGE	1 PACK

A. Package Includes:

- Seafarer molded seat with off white cushions
- 2-7/8" locking Trac-Lock™ swivel, rotates 360°
- Fixed height pedestal with 9" round floor base, anodized finish

One of our smallest molded seats! Cushions are made with plush foam padding covered in marine-grade vinyl and snap easily onto seat.

Dimensions are from deck to top of swivel, and may vary slightly.

ADMIRAL PACKAGE



IMAGE	PART NUMBER	DESCRIPTION	PACK QUANTITY
A	1001408-L	ADMIRAL FIXED-HEIGHT PACKAGE	1 PACK

Package Includes:

- Admiral molded seat (cushions sold separately)
- 2-7/8" locking Trac-Lock™ swivel, rotates 360°
- Fixed height pedestal with 9" round floor base, anodized finish

Dimensions are from deck to top of swivel, and may vary slightly.

FLIP BACK SEAT



IMAGE	PART NUMBER	DESCRIPTION	PACK QUANTITY
A	1042046	FLIP BACK SEAT - WHITE w/SLIDE BENCH MOUNT	1 PACK
B	1042047	FLIP BACK SEAT - WHITE w/o SLIDE	1 PACK

Conveniently flips in either direction for your boating needs. Can use two seats for side-by-side seating. Constructed with heavy-duty marine-grade vinyl over plush foam padding.

- Back moves fore and aft
- Off white upholstery
- Weather-resistant marine-grade vinyl
- Universal mounting pattern: 5" x 12"



Back View

BENCH DOUBLE BUCKET



IMAGE	PART NUMBER	DESCRIPTION	PACK QUANTITY
A	1042050	DOUBLE BUCKET SEAT	1 PACK
B	2100196	REPLACEMENT COVER	1 PACK

Bench seating for two. Unique flip back feature allows for fore and aft seating. Thick foam padding covered in marine-grade vinyl over a high-strength composite substrate. Works with pedestal or box style mounting.

- Provides 35.5" of seating area
- Back moves fore and aft
- Off white upholstery

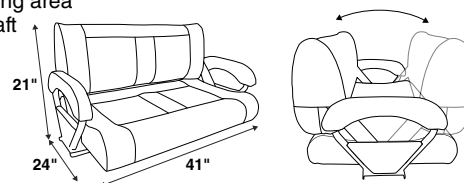

Back View

TWIN 46 FLIP-UP SEAT

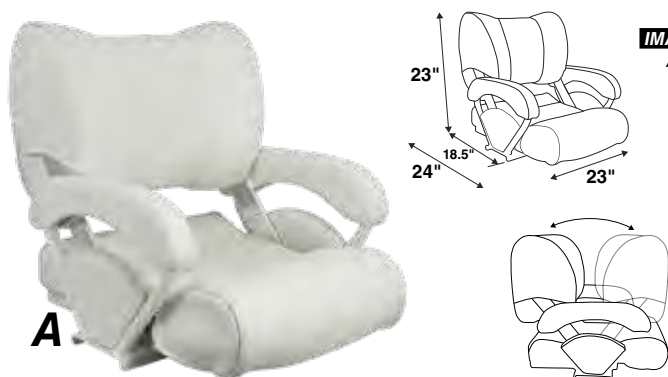

IMAGE	PART NUMBER	DESCRIPTION	PACK QUANTITY
A	1043001	TWIN 46 FLIP-UP SEAT	1 PACK

Lots of versatility with this seat. A comfortable seat for flip-up bolster for leaning and standing position, or flip the chair back for the fore and aft position. Foam padding covered with weather-resistant marine-grade vinyl.

- Flip-up bolster
- Back moves fore and aft
- Off white upholstery
- Universal mounting pattern: 5" x 5"



Flip-Up Bolster



Lean Position

DELUXE SPORT BUCKET



IMAGE	PART NUMBER	DESCRIPTION	PACK QUANTITY
A	1043691	DELUXE SPORT SEAT - NAVY-WHITE	1 PACK
B	1043693	DELUXE SPORT SEAT - CHARCOAL-WHITE	1 PACK
C	1043699	DELUXE SPORT SEAT - WHITE	1 PACK

Premium upholstery and cushions are designed to provide maximum comfort and quality. Durable blow molded frame with ergonomically molded cushions and extended sides for extra support.

- Sorrento vinyl
- Weather-resistant marine-grade vinyl
- Universal mounting pattern: 5" x 12"

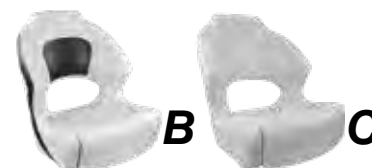

B

C

DELUXE SPORT FLIP-UP



IMAGE	PART NUMBER	DESCRIPTION	PACK QUANTITY
A	1043251	DELUXE SPORT FLIP-UP SEAT - NAVY-WHITE	1 PACK
B	1043253	DELUXE SPORT FLIP-UP SEAT - CHAR-WHITE	1 PACK
C	1043259	DELUXE SPORT FLIP-UP SEAT - WHITE	1 PACK
D	1043263	DELUXE SPORT FLIP-UP SEAT - CHARCOAL-GRAY	1 PACK

Comfort and support seat, flip-up bolster for standing or leaning positions. Blow molded frame with molded foam. Premium high-quality upholstery with marine-grade vinyl.

- Sorrento vinyl
- Flip-up bolster
- Lightweight blow molded frame
- Weather-resistant marine-grade vinyl
- Universal mounting pattern: 5" x 12"

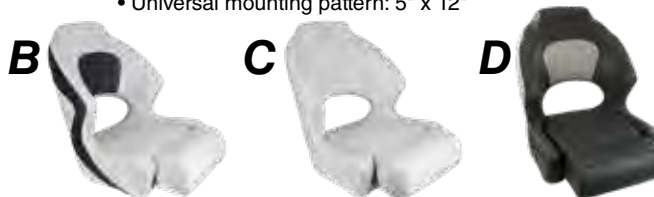

DELUXE SPORT FLIP-UP II



IMAGE	PART NUMBER	DESCRIPTION	PACK QUANTITY
A	1043260	DLX FLIP-UP II CARBON FIBER CHAR-LT GRAY	1 PACK

Next generation of comfort and support. Deluxe sport flip-up II with gray carbon fiber texture and light gray luxury vinyl. Lightweight and sturdy molded frame with high-density foam padding. Flip-up bolster with a plush cushion for a comfortable leaning position.

- Universal mounting pattern: 5" x 12"
- Marine-grade vinyl is UV-treated, mildew-resistant, and water-resistant

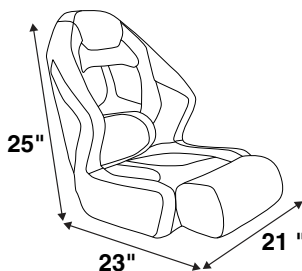

SUBSTRATE & FOAM DELUXE SPORT



IMAGE	PART NUMBER	DESCRIPTION	PACK QUANTITY
A	1043250-SFB	DS FLIP-UP SEAT - SUB, FOAM & BOLSTER ONLY	1 PACK
B	1043250-SFB1	DS FLIP-UP SEAT - SUB, FOAM, PARALLEL BOLSTER	1 PACK
C	1043250-SF	DELUXE SPORT FLIP-UP SEAT - SUB, FOAM	1 PACK

Premium upholstery and cushions are designed to provide maximum comfort and quality. Durable blow molded frame with ergonomically molded cushions and extended sides for extra support.

- Universal mounting pattern: 5" x 12"

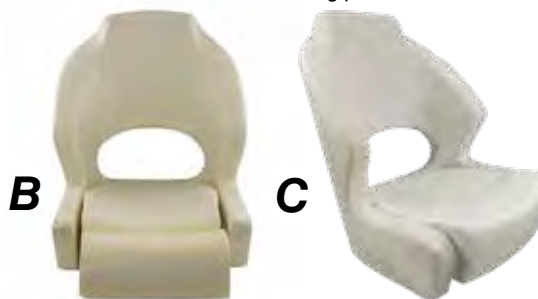

BOTTOM OF SUBSTRATE

PRO FISHING SPEED SEAT

IMAGE	PART NUMBER	DESCRIPTION	PACK QUANTITY
A	1040940-01	PRO FISHING SPEED SEAT - CHAR-BLK-MD GRAY	1 PACK
B	1040940-02	PRO FISHING SPEED SEAT - CHAR-MD GRAY-BURG	1 PACK
C	1040940-03	PRO FISHING SPEED SEAT - CHAR-MD GRAY-RED	1 PACK



A



B



C

Elevate your fishing game with the all-new pro fishing speed seats. Pull out seat cushions for direct mount applications!

- Open armrests double as grab handles
- Universal mounting pattern: 5" x 12"
- Mounts to a deck or seat mount
- Marine-grade vinyl is UV-treated, mildew-resistant, and water-resistant

UPHOLSTERED SEATS

BASS HELM SEAT

IMAGE	PART NUMBER	DESCRIPTION	PACK QUANTITY
A	1045150	BASS HELM SEAT - GRAY	1 PACK
B	1045150-01	BASS HELM SEAT - MD GRAY-LIT GRAY	1 PACK



A



B

Comfort and style in one! Pull out seat cushions for direct-mount applications to deck or seat mount.

- Universal mounting pattern: 5" x 12"
- Marine-grade vinyl is UV-treated, mildew-resistant, and water-resistant

YACHTSMAN HELM FULLY UPHOLSTERED

IMAGE	PART NUMBER	DESCRIPTION	PACK QUANTITY
A	1060430-01	YACHTSMAN FULLY UPH HELM - CHAR-GRAY	1 PACK
B	1060430-02	YACHTSMAN FULLY UPH HELM - CHAR-MD GRAY	1 PACK



A



B

Made with one-piece white molded shell made from LLDPE plastic with UV inhibitors for years of carefree use.

- Universal mounting pattern: 5" x 12"
- Marine-grade vinyl
- Designed with heat seal channels and quick-dry construction

OZARK SPORT II

IMAGE	PART NUMBER	DESCRIPTION	PACK QUANTITY
A	1043325	OZARK SPORT II, RED & BLACK	1 PACK
B	1043334	OZARK SPORT II, WHITE & BLACK	1 PACK



A



B

The Ozark Sport II seat with premium high-quality upholstery and cushions on a rigid aluminum frame built for maximum support and comfort.

- Premium upholstery
- Weather-resistant marine-grade vinyl
- Universal mounting pattern: 5" x 5" and 5" x 12"
- Molded foam cushions

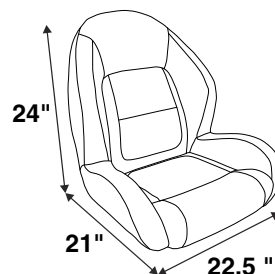

OZARK SEATS

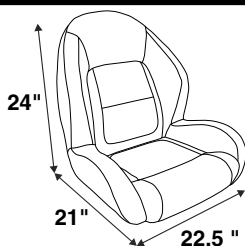

IMAGE	PART NUMBER	DESCRIPTION	PACK QUANTITY
A	1003224	OZARK, 3-PIECE BENCH - CHARCOAL-MED GRAY	1 PACK
B	1043224	OZARK, SEAT - CHARCOAL-MED GRAY	1 PACK
C	1043224-B	OZARK, SEAT w/BOLSTER - CHARCOAL-GRAY	1 PACK
D	1043224-CS	OZARK, CENTER FOLDING - CHARCOAL-GRAY	1 PACK
E	1040224	OZARK, CASTING SEAT - CHARCOAL-GRAY	1 PACK

The Ozark seat is available in a variety of options and styles, with premium high-quality upholstery and cushions on a rigid aluminum frame for maximum support and comfort.

- Premium upholstery
- Weather-resistant marine-grade vinyl
- Universal mounting pattern: 5" x 5" and 5" x 12"



A



B



C



D



E

SUBSTRATE & FOAM OZARK

IMAGE	PART NUMBER	DESCRIPTION	PACK QUANTITY
A	1043200-SF	OZARK, SEAT - SUBSTRATE & FOAM	1 PACK
B	1043200-SFB1	OZARK, SEAT - SUB, FOAM & PARALLEL BOLSTER	1 PACK



B



A



Bolster Hinges

SPORT BUCKET SEAT

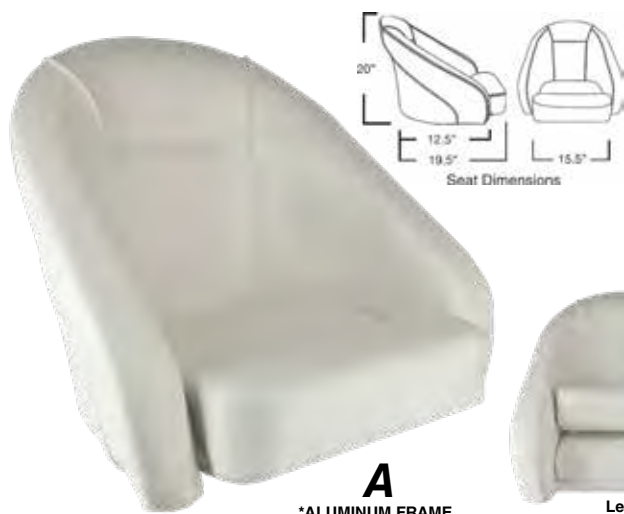

A
*ALUMINUM FRAME

IMAGE	PART NUMBER	DESCRIPTION	PACK QUANTITY
A*	1043501	SPORT BUCKET FLIP-UP SEAT - WHITE	1 PACK
B*	1040407	BUCKET SEAT - WHITE	1 PACK

Comfort and smooth riding on this seat. Plush foam padding covered in marine-grade vinyl. Flip-up bolster converts easily from sit down to stand up leaning support.

- Flip-up bolster
- Weather-resistant marine-grade vinyl
- Universal mounting pattern: 5" x 12"

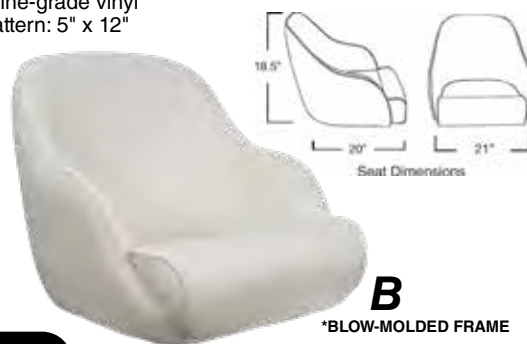

B
*BLOW-MOLDED FRAME

UPHOLSTERED SEATS

STINGRAY SEAT



A

IMAGE	PART NUMBER	DESCRIPTION	PACK QUANTITY
A	1040930-01	STINGRAY SPORT BUCKET FLIP-UP - BLACK-GRAY	1 PACK

Comfortable runabout seat or flip-up the bolster for standing or leaning position. Blow molded high-strength composite shell with high-density foam padding, covered in marine-grade vinyl.

- Flip-up bolster
- Weather-resistant marine-grade vinyl
- Universal mounting pattern: 5" x 12"



Lean Position

OCEAN FLIP-UP SEAT



A

IMAGE	PART NUMBER	DESCRIPTION	PACK QUANTITY
A	1040900	OCEAN FLIP-UP SEAT - WHITE	1 PACK

Comfortable runabout seat or flip-up the bolster for standing or leaning position. Blow molded high-strength composite shell with high-density foam padding, covered in marine-grade vinyl.

- Flip-up bolster
- Large dry pocket on back of seat
- Weather-resistant marine-grade vinyl
- Universal mounting pattern: 5" x 12"



Flip-up Bolster



Mesh Pocket

FLIP-UP HELM



IMAGE	PART NUMBER	DESCRIPTION	PACK QUANTITY
A	1042035-W	CONSOLE HELM FLIP-UP - WHITE	1 PACK
B	1042035-BLK	CONSOLE HELM FLIP-UP - BLACK-GRAY	1 PACK
C	1042035-SFB	CONSOLE HELM FOAM SUBSTRATE	1 PACK

Available in luxury vinyl of brilliant white or black w/gray supported by a durable frame with high-density foam padding contoured for ergonomic support. Cushioned armrests flip up and out of the way with ease.

- Flip-up bolster with a plush cushion for a comfortable leaning position
- Universal mounting pattern: 5" x 12"
- Marine-grade vinyl is UV-treated, mildew-resistant, and water-resistant



LADDER BACK SEATS



IMAGE	PART NUMBER	DESCRIPTION	PACK QUANTITY
A	1061301	LADDER BACK SEAT - w/WHITE CUSHIONS	1 PACK
B	1061302	LADDER BACK SEAT - w/WHITE CUSHIONS & GIMBAL	1 PACK

2-piece plastic injection seat covered with a UV-stabilized polypropylene substrate for durability. Molded armrests with polished aluminum brackets.

- Molded grab handle on back of seat
- Removable snap on cushions
- Universal mounting pattern: 5" x 12"

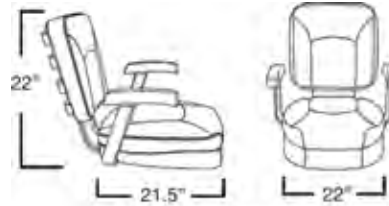

Seat Dimensions



Gimbal



Back View

LADDER BACK CHAIR PACKAGES



IMAGE	PART NUMBER	DESCRIPTION	PACK QUANTITY
A	1001303	LADDER BACK CHAIR PACKAGE	1 PACK
B	1001304	LADDER BACK CHAIR PACKAGE w/GIMBAL	1 PACK
C	1001305	LADDER BACK PORTABLE DECK STAND PACKAGE	1 PACK

Packages Include:

- 2-piece plastic injection seat with armrests and white cushions
- 2-7/8" locking Trac-Lock™ slide/swivel (locking), rotates 360°
- Slide travels 5-1/4" fore and aft
- 18" fixed height pedestal with 9" round base, anodized finish



Dimensions are from top of deck to top of slide & swivel and may vary slightly

DELUXE CAPTAIN'S CHAIR



A



IMAGE	PART NUMBER	DESCRIPTION	PACK QUANTITY
A	1040006	ELEMENTS AGUA® COASTAL SHORELINE™	1 PACK

Deluxe captain's chair with licensed Mossy Oak® Elements Agua® Coastal Shoreline™ pattern. Anodized aluminum supports with durable plastic substrate with cushioned armrests for added comfort.

- Universal mounting pattern: 5" x 12" and 5" x 5"
- Marine-grade vinyl is UV-treated, mildew-resistant, and waterproof.

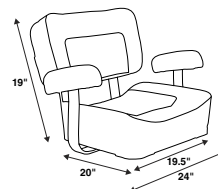

UPHOLSTERED SEATS

DELUXE UPHOLSTERED



A

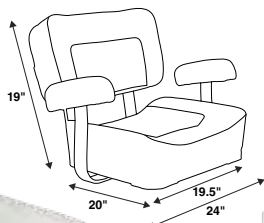

Side View

IMAGE	PART NUMBER	DESCRIPTION	PACK QUANTITY
A	1040809	DELUXE UPHOLSTERED SEAT - WHITE	1 PACK
B	1040002	DELUXE UPHOLSTERED SEAT w/ARMRESTS - WHITE	1 PACK
C	1040009	DELUXE UPHOLSTERED SEAT w/ARMRESTS - BLACK	1 PACK

Perfect for comfortably riding out rough conditions. High-density foam cushions covered in marine-grade vinyl for maximum comfort and durability.

- Universal mounting pattern: 5" x 12" and 5" x 5"
- Anodized aluminum back support bars
- (B.) Armrest supports and cushions
- Plastic durable substrate

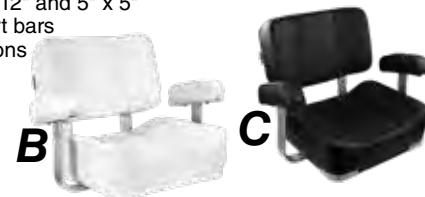

B

C

DELUXE CHAIR STAND



A

B

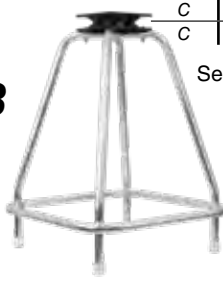

C

Deluxe Chair Stand w/Swivel

IMAGE	PART NUMBER	DESCRIPTION	PACK QUANTITY
A	1020003	DELUXE CAPTAIN'S CHAIR PACKAGE - WHITE	1 PACK
B	1020009	DELUXE CAPTAIN'S CHAIR PACKAGE - BLACK	1 PACK
C	1080018	DELUXE CAPTAIN'S CHAIR STAND w/SWIVEL, 24"	1 PACK
C	1080019	DELUXE CAPTAIN'S CHAIR STAND w/SWIVEL, 15"	1 PACK
C	1080020	DELUXE CAPTAIN'S CHAIR STAND w/SWIVEL, 29"	1 PACK

Seat rotates 360°. Chair stand has 1" anodized legs with rubber tip guards.

- Anodized aluminum arm and back support bars
- Plastic durable substrate



BAR STOOLS



A

B

IMAGE	PART NUMBER	DESCRIPTION	PACK QUANTITY
A	1081224-G	24" STAINLESS STEEL BAR STOOL PACKAGE	1 PACK
B	1081224-GAL	24" ALUMINUM BAR STOOL PACKAGE	1 PACK
A	1081230-G	30" STAINLESS STEEL BAR STOOL PACKAGE	1 PACK
B	1081230-GAL	30" ALUMINUM BAR STOOL PACKAGE	1 PACK
C	1081233	BAR STOOL SEAT - GRAY	1 PACK

Durable 15" round bar stool seat with thick plush cushion provides support and comfort. 2-7/8" pedestal, available in 316 mirror finish stainless steel or high-strength aluminum.

- Stainless steel arched back support
- Chrome Trac-lock™ swivel
- 14" Round stainless steel or aluminum footrest



15" Round Bar Stool Seat



LEANING STAND



Side View

IMAGE	PART NUMBER	DESCRIPTION	PACK QUANTITY
A	1080080-06	LEANING STAND PACKAGE	1 PACK
-	1045070	SEAT CUSHION, REPLACEMENT	1 PACK
-	1045075	BACKREST CUSHION, REPLACEMENT	1 PACK

High-strength anodized aluminum bent and welded frame. High-density foam padding covered with UV-treated, mildew-resistant, water-resistant marine-grade vinyl. Leaning stand packed in a box the size of cushion for shipping and storage. Package includes 4 rod holders, backrest, flip-up footrest, and strap.

- Easy assembly and installation
- Mounting hardware included
- Modular back rest and rod holder
- Strap designed for securing a cooler beneath the seat



Back View

FOLD DOWN BENCH

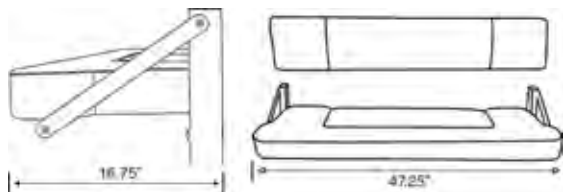

IMAGE	PART NUMBER	DESCRIPTION	PACK QUANTITY
A	1081093	FOLD DOWN BENCH SEAT - WHITE-GRAY	1 PACK
B	1081000-F	FOLD DOWN BENCH SEAT - FRAME ONLY	1 PACK

Simply lift back of seat and fold down for easy storage.

- Stainless steel frame
- Marine-grade vinyl
- Foam cushion



A



B

DOCK BENCH

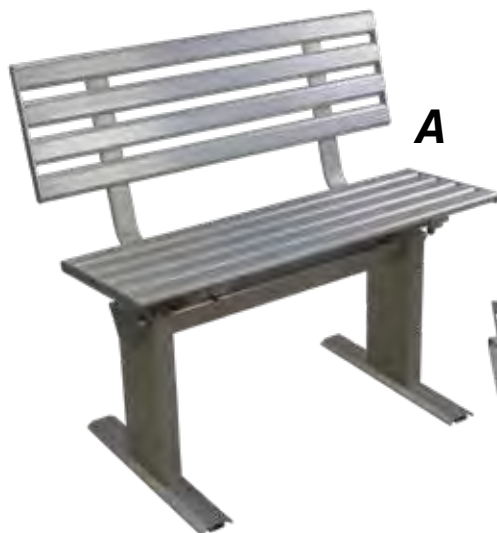

A



with Armrests

B

IMAGE	PART NUMBER	DESCRIPTION	PACK QUANTITY
A	1099050-2	ALUMINUM DOCK BENCH	1 PACK
B	1099050-2A	ALUMINUM DOCK BENCH w/ARMRESTS	1 PACK

Strong anodized aluminum frame with extruded aluminum support legs.

- Easy to assemble
- Heavy duty design
- Weather-resistant for harsh marine environment
- Packs neatly into box (19" W x 42" L x 5" D)
- Dimensions: 30" H x 38.75" W x 12" D
- Anodized aluminum



Side View



Front View

CHARTER HELM



IMAGE	PART NUMBER	DESCRIPTION	PACK QUANTITY
A	1042130-02	CHARTER HIGH-BACK - CHARCOAL	1 PACK
B	1042130-01	CHARTER HIGH-BACK - OFF WHITE	1 PACK

Luxury helm seat provides maximum comfort for long rides. Plush foam padding covered with heavy-duty marine-grade vinyl. Heavy-duty powder-coated steel frame with suspension springs.

- Back reclines 45°
- Premium adjustable, flip-up armrests
- Premium weather-resistant marine-grade vinyl
- Universal mounting pattern: 5" x 12"



Armrest angle Adjustment

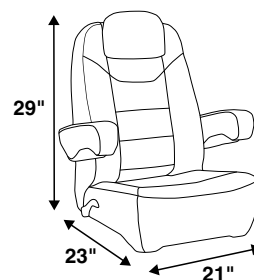

CHARTER HELM WITH BOLSTER



IMAGE	PART NUMBER	DESCRIPTION	PACK QUANTITY
A	1042135-01	CHARTER HIGH-BACK W/BOLSTER - OFF WHITE	1 PACK
B	1042145-01	CHARTER LOW-BACK W/BOLSTER - OFF WHITE	1 PACK

Luxury helm seat provides maximum comfort for long rides. Plush foam padding covered with heavy-duty marine-grade vinyl. Heavy-duty powder-coated steel frame with suspension springs.

- Back reclines 45°
- Premium adjustable, flip-up armrests
- Premium weather-resistant marine-grade vinyl
- Universal mounting pattern: 5" x 12"



Armrest angle Adjustment

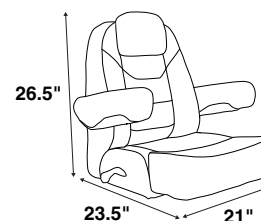

PONTOON HELM



IMAGE	PART NUMBER	DESCRIPTION	PACK QUANTITY
A	1042185-01	PONTOON HELM RECLINE - CREAM	1 PACK
B	1042180-01	PONTOON HELM FIXED - CREAM	1 PACK

Pontoon helm seats offer a heavy-duty powder-coated steel frame with suspension springs. 6" foam cushions covered in marine-grade vinyl.

- Armrests flip-up
- Weather-resistant marine-grade vinyl
- Universal mounting pattern: 5" x 12"
- (A) back reclines 45°



Armrest angle adjustment



Side Angle

MARINER HELM



A



B



C

IMAGE	PART NUMBER	DESCRIPTION	PACK QUANTITY
A	1042081-BC	MARINER HELM CHAIR - BLACK-CHARCOAL	1 PACK
B	1042080-W	MARINER HELM CHAIR - WHITE	1 PACK
C	1042080-B	MARINER HELM CHAIR - BLACK	1 PACK

Luxury helm seat with plush foam padding covered in marine-grade vinyl and heavy-duty powder-coated steel frame.

- Back reclines 45°
- Universal mounting pattern: 5" x 12"



Seat Dimensions

WHEELHOUSE HELM



A

IMAGE	PART NUMBER	DESCRIPTION	PACK QUANTITY
A	1042120-XLB1	WHEELHOUSE XL HELM SEAT - BLACK	1 PACK

Wheelhouse helm seat offers a heavy-duty powder-coated steel shock absorbing suspension seat frame with 9" thick foam cushions covered in marine-grade vinyl.

- Back reclines 45°
- Adjustable flip-up armrests
- Universal mounting pattern: 5" x 12"
- Pocket on back of seat



Seat Dimensions



Armrest angle Adjustment



Side Angle

HELMSMAN PILOT SEAT



A

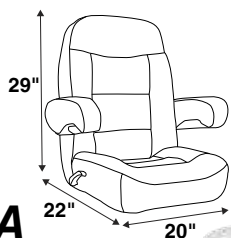

IMAGE	PART NUMBER	DESCRIPTION	PACK QUANTITY
A	1042110-B1	HELMSMAN RECLINING PILOT SEAT - BLACK	1 PACK
B	1042110-W1	HELMSMAN RECLINING PILOT SEAT - WHITE	1 PACK

Helmsman pilot seat offers a heavy-duty powder-coated steel shock absorbing suspension seat frame. 6" thick foam cushions covered in marine-grade vinyl.

- Back reclines 45°
- Flip-up armrests
- Universal mounting pattern: 5" x 12"



B



Armrest angle Adjustment



Side Angle

CHARTER PACKAGE



IMAGE	PART NUMBER	DESCRIPTION	PACK QUANTITY
A	1002130	FIXED HEIGHT CHARTER HELM PACKAGE - CHAR	1 PACK

Package includes:

- Charter helm seat w/heavy-duty 4" workhorse slide & swivel
- 4" fixed height brite dip pedestal w/12" round floor base
- Helmsman flip-up footrest



Charter



Workhorse II

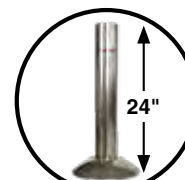

Elite



Footrest

HELMSMAN PACKAGE



IMAGE	PART NUMBER	DESCRIPTION	PACK QUANTITY
A	1002110	ADJUSTABLE HELMSMAN SEAT PACKAGE	1 PACK

Package includes:

- Helmsman pilot helm seat w/heavy-duty 4" air-ride Mariner II slide & swivel
- 4" brite dip pedestal w/12" round floor base, adjusts from 18" to 28"
- Seat mounting flip-up footrest offers adjustable height



Helmsman



Mariner II



Mainstay



Footrest

MARINER PACKAGE



IMAGE	PART NUMBER	DESCRIPTION	PACK QUANTITY
A	1002083	MARINER ADJUSTABLE PACKAGE	1 PACK

Package includes:

- Mariner helm seat
- Heavy-duty 4" air-ride Mariner II slide & swivel
- 4" brite dip pedestal w/12" round floor base, adjusts from 18" to 28"
- Seat mounting flip-up footrest offers adjustable height



Mariner



Mariner II



Mainstay



Footrest

VINYL COLLECTION

VINYL COLLECTION

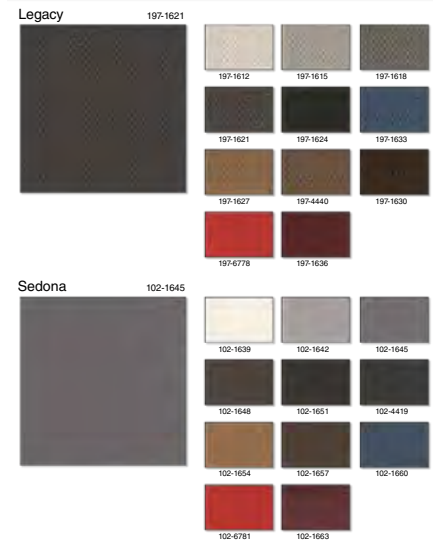
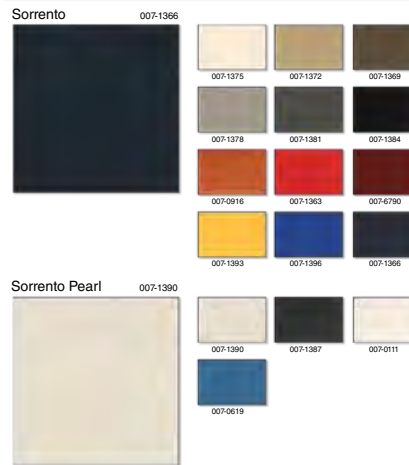
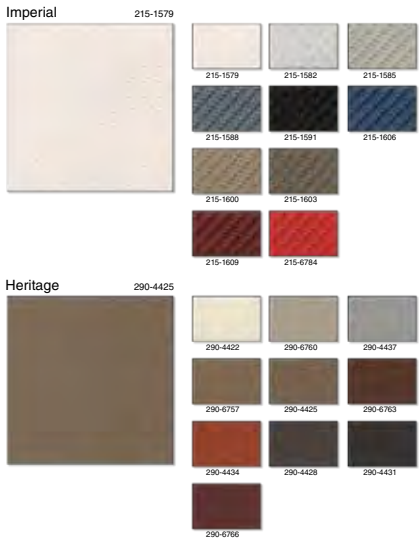
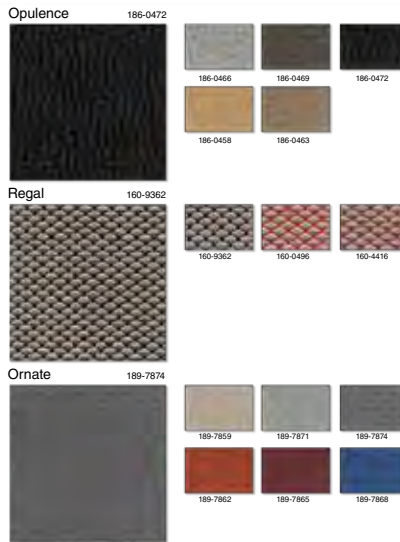
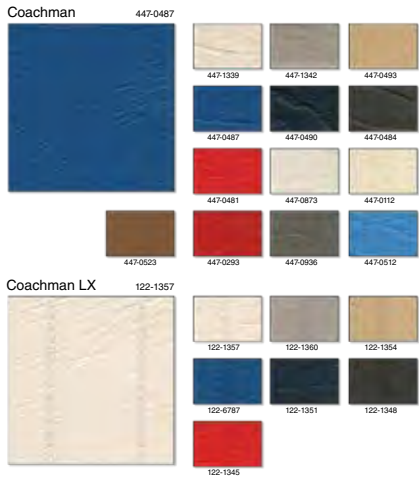

scheco Marine Upholstery Vinyl & Fabric Collection

Performance Testing	Testing Method
Meets or exceeds	
<ul style="list-style-type: none"> • Flame Resistance • Abrasion Resistance • UV Resistance • Cold Crack • Mildew Treated • Anti-Bacterial • Anti-Microbial 	FMVSS 302 Flammability Test (horizontal burning) Heavy Duty Wyzenbeek ASTM D4157-92 Double Rub, 100,000+ Cycles ASTM G35 QUV Stabilized 500 Hours, Gray Scale 3.5 min. -23°C Per FTMS 191A M5874 ASTM G21-2009 ATCC 147-1993 ASTM 1428-99
Manufactured to meet the following flammability requirements:	
California Technical Bulletin 117 Section E	
NFPA 260	BIFMA X5.7
FAA, FAR. 25.853	UIFAC Class 1
	IMO A.652 (16) 1, 8.2 & 8.3
	NF P92-503 M2
	DIN 4102 B2
	EN 1021 Part 1 & 2



DOWNLOAD THE CATALOG



Marine Equipment Directive 96/98/EC

- SEAT MOUNTS
- PEDESTALS
- BASES
- ACCESSORIES
- PACKAGES

KingPin™

Upgrade Your Boat with **SPRINGFIELD Marine's** KingPin™ Seating System!

Discover the ultimate in safety and reliability with **SPRINGFIELD Marine's** first-generation removable pedestal, the KingPin™. A favorite among boaters, the KingPin™ system features the versatile Hi-Lo pedestal. Enjoy a high position for comfortable fishing or easily switch to the low position for compact storage and maximum visibility while underway. Perfect for fishing trips, leisure boating, and beyond.

Crafted with a 3/4" E-coated steel pin, the KingPin™ ensures a secure fit into the deck base. Choose from corrosion-resistant anodized, e-coated, or polished aluminum posts. Available in standard and threaded styles, both designed for a safe and secure boating experience. Ready to elevate your boating adventures?

System meets ABYC H-31 B Rating.

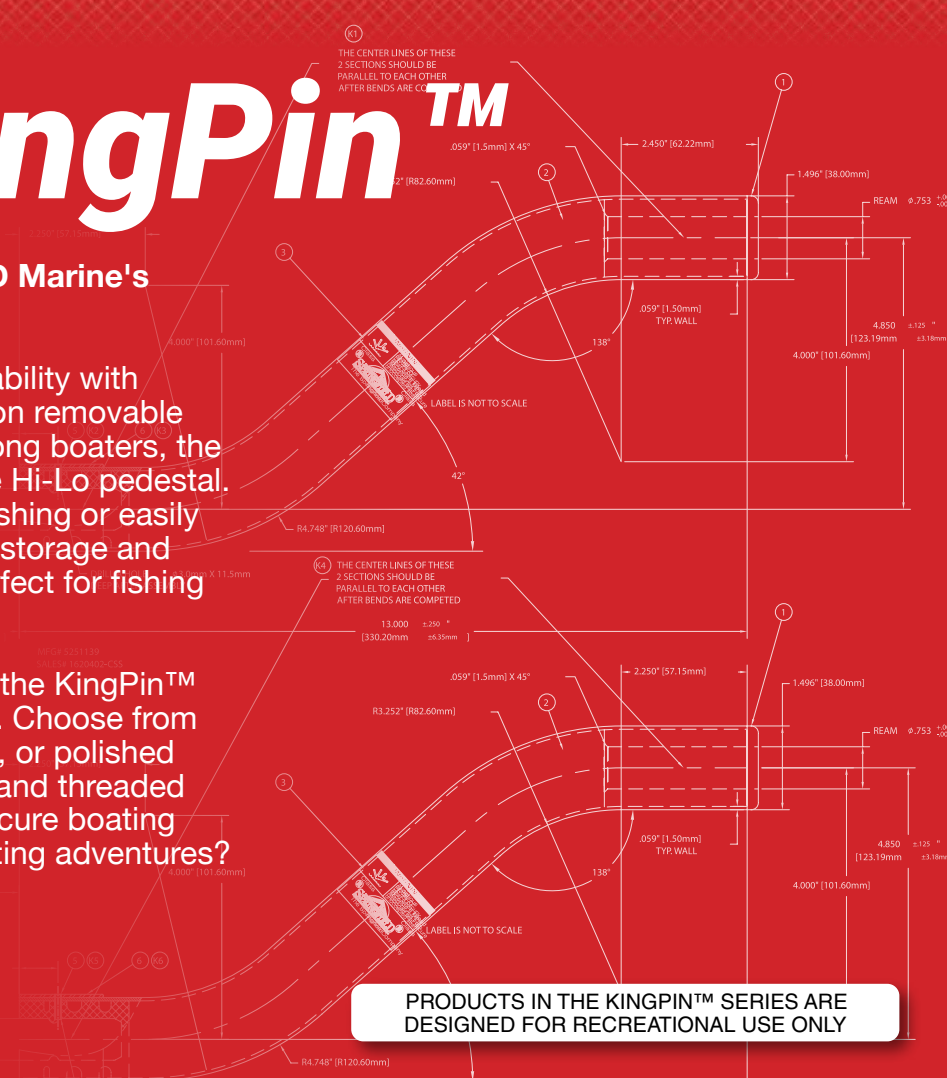

PRODUCTS IN THE KINGPIN™ SERIES ARE DESIGNED FOR RECREATIONAL USE ONLY

KINGPIN™ SERIES

HI-LO 3-PIECE PACKAGE

KINGPIN™ SERIES

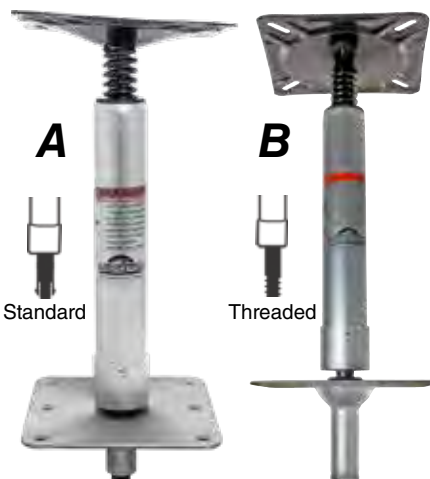

IMAGE	PART NUMBER	DESCRIPTION	UNIT HEIGHT	PACK QUANTITY	ABYC
A	1615431-1	STANDARD HI-LO 3-PIECE PACKAGE	13-1/2"	1 RETAIL	B
A	1615433-1	STANDARD HI-LO 3-PIECE PACKAGE	15-1/2"	1 RETAIL	B
B	1630401-1	THREADED HI-LO 3-PIECE PACKAGE	13-1/2"	1 RETAIL	B

Retail packed in box with 4-color label

Hi-Lo 3-Piece package (A) includes the following parts:

- Standard KingPin™ 11" or 13" post (#1610411-A of 1610413-A)
- KingPin™ Hi-Lo swivel, e-coat finish (#1615201-EC)
- Standard KingPin™ 7" x 7" base, stainless steel with satin finish (#1620001)

Hi-Lo 3-Piece package (B) includes the following parts:

- Threaded KingPin™ 11" post (#1630411-A)
- KingPin™ Hi-Lo swivel, e-coat finish (#1615201-EC)
- Threaded KingPin™ 7" x 7" base, stainless steel with satin finish (#1630001)

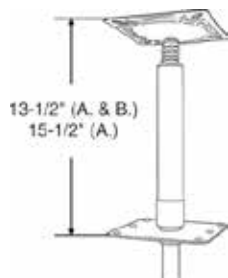

POWER-RISE STAND-UP POST



RETAIL IMAGE	PART NUMBER	PIN	ADJUSTS	FINISH	PACK QUANTITY	ABYC
A	1612402-A	STANDARD	22-1/2" TO 29-1/2"	ANODIZED	1 RETAIL	B
B	1632013-A	THREADED	22-1/2" TO 29-1/2"	ANODIZED	1 RETAIL	B

Retail packed in clamshell with 4-color label

OEM IMAGE	PART NUMBER	PIN	ADJUSTS	FINISH	PACK QUANTITY	ABYC
A	3612402-A	STANDARD	22-1/2" TO 29-1/2"	ANODIZED	1 BULK	B
B	3632013-A	THREADED	22-1/2" TO 29-1/2"	ANODIZED	2 BULK	B
C	3632013-EC	THREADED	22-1/2" TO 29-1/2"	E-COAT	2 BULK	B

Power-rise stand-up anodized aluminum post adjusts from 22-1/2" to 29-1/2". Use with standard or threaded KingPin™ base (sold separately).

- Cast aluminum seat mount with black textured powder-coated finish
 - 5" x 5" bolt pattern
 - 3° Degree tilt
- Aluminum-clad gas cylinder inner post



POWER-RISE SIT DOWN POST

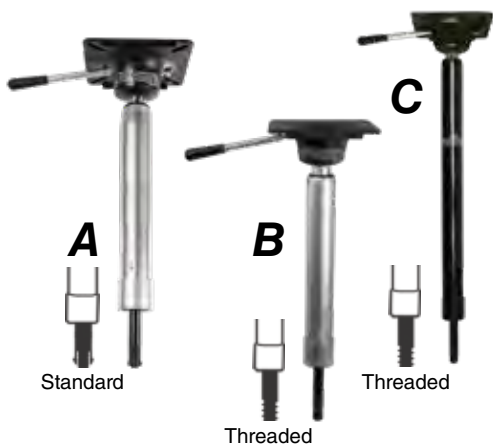

RETAIL IMAGE	PART NUMBER	PIN	ADJUSTS	FINISH	PACK QUANTITY	ABYC
A	1612401-A	STANDARD	16" TO 22-3/8"	ANODIZED	1 RETAIL	B
B	1632012-A	THREADED	16" TO 22-3/8"	ANODIZED	1 RETAIL	B

Retail packed in clamshell with 4-color label

OEM IMAGE	PART NUMBER	PIN	ADJUSTS	FINISH	PACK QUANTITY	ABYC
B	3632012-A	THREADED	16" TO 22-3/8"	ANODIZED	1 BULK	B
C	3632012-EC	THREADED	16" TO 22-3/8"	E-COAT	1 BULK	B

Power-rise stand-up anodized aluminum post adjusts from 16" to 22-3/8". Use with standard or threaded KingPin™ base (sold separately).

- Cast aluminum seat mount with black textured powder-coated finish
 - 5" x 5" bolt pattern
 - 3° Degree tilt
- Aluminum-clad gas cylinder inner post



POWER-RISE STAND-UP PACKAGE

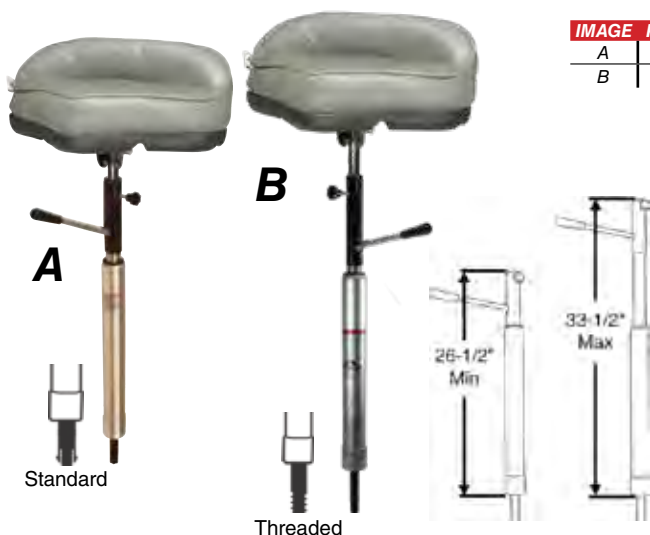

IMAGE	PART NUMBER	DESCRIPTION	PIN	PACK QUANTITY	ABYC
A	1611433	POWER-RISE STAND-UP PACKAGE	STANDARD	1 RETAIL	B
B	1631037	POWER-RISE STAND-UP PACKAGE	THREADED	1 RETAIL	B

Retail packed in box with 4-color label

Stand-up package (A) includes the following parts:

- Standard Power-rise Stand-up post (#1611431-A)
- Quik-Tilt seat mount (#1615254-EC)
- Gray Pro Stand-up seat (#1040213)

Stand-up package (B) includes the following parts:

- Threaded Power-rise Stand-up post (#1633013-A)
- Quik-Tilt seat mount (#1615254-EC)
- Gray Pro Stand-Up seat (#1040213)



KINGPIN™ SERIES

POWER-RISE POST

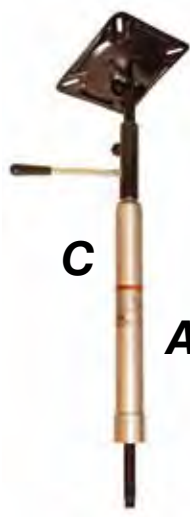

RETAIL IMAGE	PART NUMBER	DESCRIPTION	PIN	ADJUSTS	FINISH	PACK QUANTITY	ABYC
A	1611431-A	POWER-RISE POST ONLY	STANDARD	15-1/2" TO 18-1/2"	ANODIZED	2 RETAIL	B
B	1633013-A	POWER-RISE POST ONLY	THREADED	22-1/2" TO 29-1/2"	ANODIZED	2 RETAIL	B
C	1631038	2-PC POWER-RISE STAND-UP PKG	THREADED	22-1/2" TO 29-1/2"	ANODIZED	1 RETAIL	B

Retail packed in box with 4-color label

OEM IMAGE	PART NUMBER	DESCRIPTION	PIN	ADJUSTS	FINISH	PACK QUANTITY	ABYC
A	3633011-SSA	POWER-RISE POST ONLY	THREADED SS	15-1/2" TO 18-1/2"	ANODIZED	10 BULK	B
B	3633013-A	POWER-RISE POST ONLY	THREADED E-COAT	22-1/2" TO 29-1/2"	ANODIZED	10 BULK	B
C	3633013-SSA	POWER-RISE POST ONLY	THREADED SS	22-1/2" TO 29-1/2"	ANODIZED	10 BULK	B

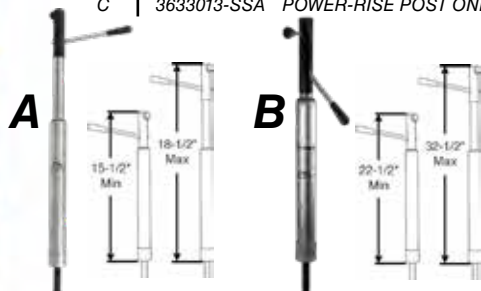

Easily stow in rod locker.
Use with standard or threaded KingPin™ base (sold separately).
Pedestals listed as SSA have a Stainless Steel pin and anodized post. Use with any KingPin™ seat mount.

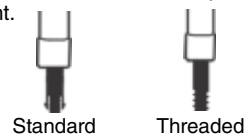

QUIK-TILT SEAT MOUNT

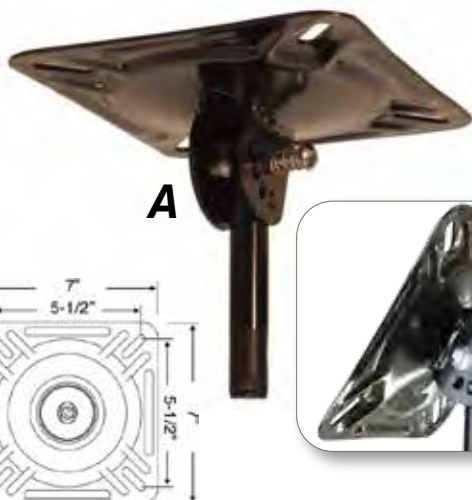

RETAIL IMAGE	PART NUMBER	DESCRIPTION	FINISH	PACK QUANTITY	ABYC
A	1615254-EC	QUIK-TILT SEAT MOUNT	E-COAT	1 RETAIL	B

Retail packed in clamshell with 4-color label

OEM IMAGE	PART NUMBER	DESCRIPTION	FINISH	PACK QUANTITY	ABYC
A	3615254-EC	QUIK-TILT SEAT MOUNT	E-COAT	20 BULK	B

E-coat rust-resistant finish swivel rotates 360°. Use with any KingPin™ post (sold separately).

- 4 snap-in angles (0°, 30°, 60°, 90°)



KINGPIN™ SERIES

7" X 7" SWIVEL SEAT MOUNT

KINGPIN™ SERIES

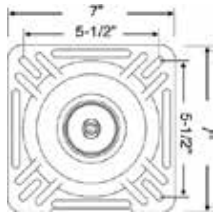

RETAIL IMAGE	PART NUMBER	DESCRIPTION	FINISH	PACK QUANTITY	ABYC
A	1614201-PP	SEAT MOUNT WITH SPRING	POLISHED	6 RETAIL	B
A	1615201-EC	SEAT MOUNT WITH SPRING	E-COAT	6 RETAIL	B
B	1615204-EC	SEAT MOUNT NO SPRING	E-COAT	6 RETAIL	B

Retail packed in box with 4-color label

OEM IMAGE	PART NUMBER	DESCRIPTION	FINISH	PACK QUANTITY	ABYC
A	3614201-PP	SEAT MOUNT WITH SPRING	POLISHED	20 BULK	B
B	3614204-PP	SEAT MOUNT NO SPRING	POLISHED	20 BULK	B
A	3615201-EC	SEAT MOUNT WITH SPRING	E-COAT	20 BULK	B
B	3615204-EC	SEAT MOUNT NO SPRING	E-COAT	20 BULK	B

Unintentional detachment to comply with ABYC. E-coat or polished passivated rust-resistant finish. Polish passivated swivels are stainless steel.

- Fits bolt pattern 4.5" to 5.5" square
- Swivel rotates 360°
- Seat mount has 3° tilt.
- Use with any KingPin™ post (sold separately)



7" X 7" HI-RISE SEAT MOUNT



SWIVEL ADDS 2-11/16" TO HEIGHT OF POST

OEM IMAGE	PART NUMBER	DESCRIPTION	PIN	FINISH	PACK QUANTITY	ABYC
A	3615207-ECB	7" X 7" HI-RISE SEAT MOUNT	MILD STEEL	E-COAT	20 BULK	B

Retail packed in clamshell with 4-color label

Unintentional detachment to comply with ABYC. Aluminum cast powder-coated finish.

- Swivel rotates 360°
- Seat mount has 3° tilt.
- Use with any KingPin™ post (sold separately)

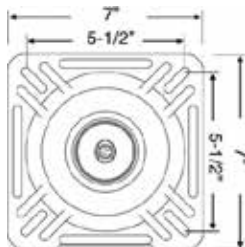

MANUAL ADJUSTABLE POST

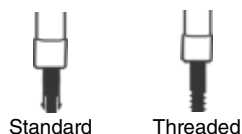
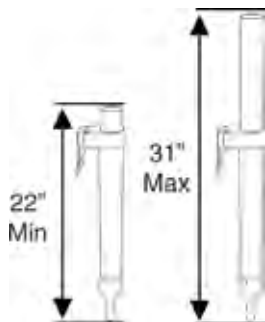

RETAIL IMAGE	PART NUMBER	PIN	FINISH	PACK QUANTITY	ABYC
A	1613401-EC	STANDARD	E-COAT	6 RETAIL	B
B	1613402-A	STANDARD	ANODIZED	6 RETAIL	B
A	1630801-EC	THREADED	E-COAT	6 RETAIL	B
B	1630801-A	THREADED	ANODIZED	6 RETAIL	B

Retail packed in clamshell with 4-color label

OEM IMAGE	PART NUMBER	PIN	FINISH	PACK QUANTITY	ABYC
A	3613401-EC	STANDARD	E-COAT	20 BULK	B
B	3613402-A	STANDARD	ANODIZED	20 BULK	B
A	3630801-EC	THREADED	E-COAT	20 BULK	B
B	3630801-A	THREADED	ANODIZED	20 BULK	B

Manually adjustable post adjusts from 22" to 31" in 1" increments. Posi-Lock lever secures post at desired height.

- Available in anodized or e-coat finish
- Use with any KingPin™ seat mount (sold separately)
- Proprietary posi-lock system



STANDARD FIXED HEIGHT POST

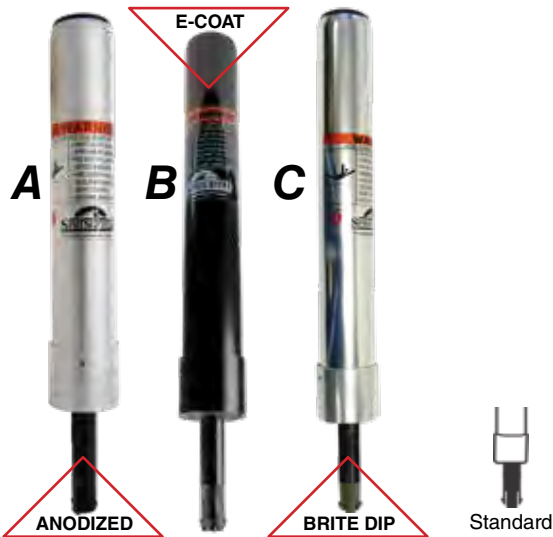

IMAGE HEIGHT	A ANODIZED	B E-COAT	C BRITE DIP	RETAIL PACK QUANTITY	ABYC
11"	1610411-A	1610411-EC	-	6 RETAIL	B
13"	1610413-A	1610413-EC	-	6 RETAIL	B
15"	1610415-A	-	-	6 RETAIL	B
25"	1610425-A	-	-	6 RETAIL	B

Retail packed in clamshell with 4-color label

IMAGE HEIGHT	A ANODIZED	B E-COAT	C BRITE DIP	OEM PACK QUANTITY	ABYC
11"	3610411-A	3610411-EC	3610411-P	20 BULK	B
13"	3610413-A	3610413-EC	3610413-P	20 BULK	B
15"	3610415-A	-	-	20 BULK	B
25"	3610425-A	-	-	20 BULK	B

Hefty 1-3/4" diameter post and reinforcement ring. Available in a variety of lengths and finishes.

- Use with any KingPin™ seat mount (sold separately)
- Use with any standard KingPin™ base (sold separately)



KINGPIN™ SERIES

THREADED FIXED HEIGHT POST

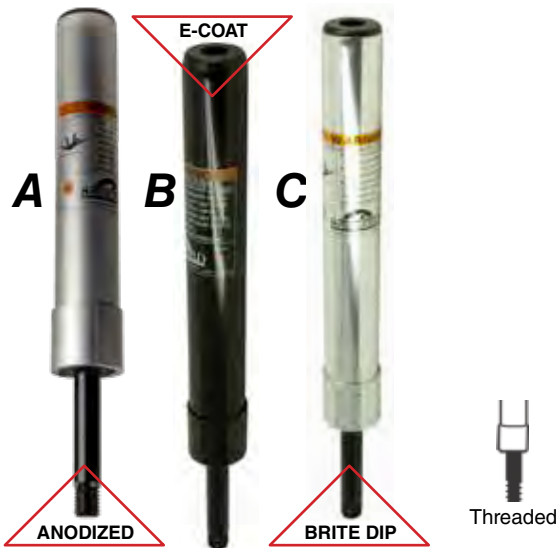

IMAGE HEIGHT	A ANODIZED	B E-COAT	C BRITE DIP	RETAIL PACK QUANTITY	ABYC
11"	1630411-A	-	-	6 RETAIL	B
13"	1630402-A	1630402-EC	-	6 RETAIL	B
15"	1630423-A	-	-	6 RETAIL	B
25"	1630415-A	-	-	6 RETAIL	B

Retail packed in clamshell with 4-color label

IMAGE HEIGHT	A ANODIZED	B E-COAT	C BRITE DIP	OEM PACK QUANTITY	ABYC
9"	-	-	3630409-P	20 BULK	B
11"	3630411-A	-	-	20 BULK	B
13"	3630402-A	3630402-EC	3630402-P	20 BULK	B
15"	3630423-A	-	3430423-P	20 BULK	B
16"	3630416-A	-	-	20 BULK	B
25"	3630414-A	3630414-EC	-	20 BULK	B

Hefty 1-3/4" diameter post and reinforcement ring. Available in a variety of lengths and finishes.

- Use with any KingPin™ seat mount (sold separately)
- Use with any standard KingPin™ base (sold separately)



STAINLESS STEEL FIXED HEIGHT POST



OEM IMAGE	PART NUMBER	POST	HEIGHT	PIN	PACK QUANTITY	ABYC
A	3610413-PSS	BRITE DIP	13"	STANDARD STAINLESS STEEL	20 BULK	B
B	3630413-SS	STAINLESS STEEL	13"	THREADED STAINLESS STEEL	20 BULK	B
C	3630402-PSS	BRITE DIP	13"	THREADED STAINLESS STEEL	20 BULK	B
D	3630402-SSA	ANODIZED	13"	THREADED STAINLESS STEEL	20 BULK	B

Retail packed in clamshell with 4-color label



Hefty 1-3/4" diameter post and reinforcement ring. Available in a variety of finishes.

- Use with any KingPin™ seat mount (sold separately)
- Use with any standard KingPin™ base (sold separately)



OFFSET POST

KINGPIN™ SERIES

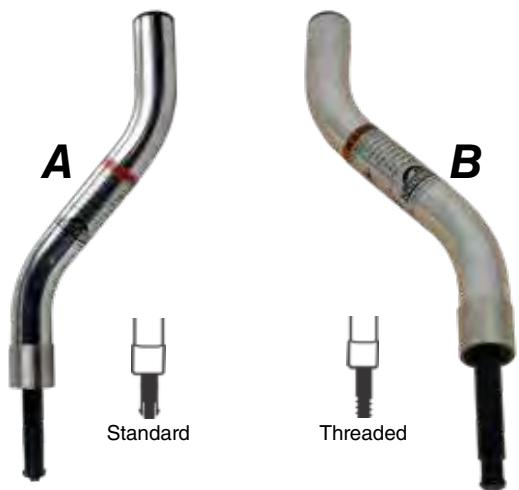

RETAIL						
IMAGE	PART NUMBER	HEIGHT	PIN	PACK QUANTITY	ABYC	
A	1610413-OSS	13"	STANDARD	6 RETAIL	B	
B	1630402-CSS	13"	THREADED	6 RETAIL	B	

Retail packed in clamshell with 4-color label

OEM						
IMAGE	PART NUMBER	HEIGHT	PIN	PACK QUANTITY	ABYC	
A	3610413-OSS	13"	STANDARD	20 BULK	B	
B	3630402-CSS	13"	THREADED	20 BULK	B	

13" hefty 1-3/4" diameter stainless steel post with mild steel e-coat pin. Provides a full 5" of offset extension.

- Use with any KingPin™ seat mount (sold separately)
- Use with any standard or threaded KingPin™ base (sold separately)



STANDARD SQUARE STEEL BASE

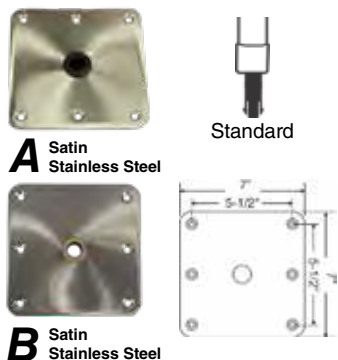

RETAIL								
IMAGE	PART NUMBER	BASE	MATERIAL	FINISH	BUSHING	PACK QUANTITY	ABYC	
A	1620001	7" X 7"	STAINLESS STEEL	SATIN	NYLON	6 RETAIL	B	
D	1620003	7" X 7" OFFSET	STAINLESS STEEL	SATIN	NYLON	6 RETAIL	B	
F	1620018	7" X 7"	MILD STEEL	BLACK KRINKLE	NYLON	6 RETAIL	B	

Retail packed in clamshell with 4-color label

OEM								
IMAGE	PART NUMBER	BASE	MATERIAL	FINISH	BUSHING	PACK QUANTITY	ABYC	
A	3620001	7" X 7"	STAINLESS STEEL	SATIN	NYLON	20 BULK	B	
B	3620001-B	7" X 7"	STAINLESS STEEL	SATIN	BRASS	20 BULK	B	
C	3620001-P	7" X 7"	STAINLESS STEEL	POLISHED	NYLON	20 BULK	B	
D	3620003	7" X 7" OFFSET	STAINLESS STEEL	SATIN	NYLON	20 BULK	B	
E	3620011	7" X 7"	MILD STEEL	E-COAT	NYLON	20 BULK	B	
F	3620018	7" X 7"	MILD STEEL	BLACK KRINKLE	NYLON	20 BULK	B	

Standard square bases, available in stainless steel or mild steel with a variety of finishes.

- 3" below deck needed
- Below deck mount (requires a 2-1/2" hole in deck)



STANDARD RECTANGULAR STEEL BASE



RETAIL								
IMAGE	PART NUMBER	BASE	MATERIAL	FINISH	BUSHING	PACK QUANTITY	ABYC	
A	1620004	6" X 8"	STAINLESS STEEL	SATIN	NYLON	6 RETAIL	B	
B	1620005	4" X 8"	STAINLESS STEEL	SATIN	NYLON	6 RETAIL	B	

Retail packed in clamshell with 4-color label

OEM								
IMAGE	PART NUMBER	BASE	MATERIAL	FINISH	BUSHING	PACK QUANTITY	ABYC	
A	3620004	6" X 8"	STAINLESS STEEL	SATIN	NYLON	20 BULK	B	
B	3620005	4" X 8"	STAINLESS STEEL	SATIN	NYLON	20 BULK	B	
C	3620005-P	4" X 8"	STAINLESS STEEL	POLISHED	NYLON	20 BULK	B	

Standard rectangular bases, available in stainless steel with a variety of finishes.

- 3" below deck needed
- Below deck mount (requires a 2-1/2" hole in deck)

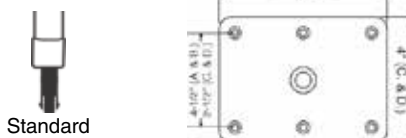
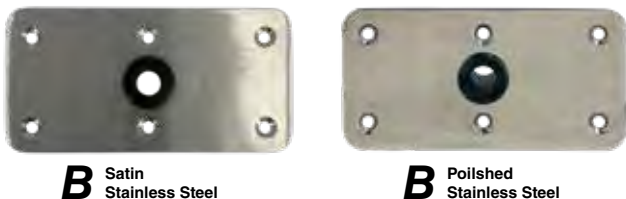

THREADED SQUARE STEEL BASE



A Satin Stainless Steel



B Polished Stainless Steel

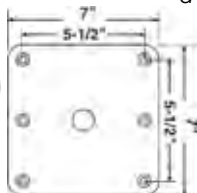

Threaded

Threaded square bases, available in polished or satin stainless steel, and mild steel with e-coat finish.

- 4" below deck needed
- Below deck mount (requires a 2-1/2" hole in deck)
- Use with any threaded KingPin™ post (sold separately)



KINGPIN™ SERIES

RETAIL IMAGE	PART NUMBER	BASE	MATERIAL	FINISH	BUSHING	PACK QUANTITY	ABYC
A	1630001	7" X 7"	STAINLESS STEEL	SATIN	NYLON	6 RETAIL	B
B	1630001-P	7" X 7"	STAINLESS STEEL	POLISHED	NYLON	6 RETAIL	B
C	1630003	7" X 7" OFFSET	STAINLESS STEEL	SATIN	NYLON	6 RETAIL	B

Retail packed in clamshell with 4-color label

OEM IMAGE	PART NUMBER	HEIGHT	MATERIAL	FINISH	BUSHING	PACK QUANTITY	ABYC
A	3630001	7" X 7"	STAINLESS STEEL	SATIN	NYLON	20 BULK	B
D	3630001-B	7" X 7"	STAINLESS STEEL	SATIN	BRASS	20 BULK	B
E	3630001-PB	7" X 7"	STAINLESS STEEL	POLISHED	BRASS	20 BULK	B
C	3630003	7" X 7" OFFSET	STAINLESS STEEL	SATIN	NYLON	20 BULK	B
F	3630020	7" X 7"	MILD STEEL	E-COAT	NYLON	20 BULK	B
F	3630020-NB	7" X 7"	MILD STEEL	E-COAT	N/A	20 BULK	B
G	3630020-OS	7" X 7" OFFSET	MILD STEEL	E-COAT	NYLON	20 BULK	B
G	3630020-OSNB	7" X 7" OFFSET	MILD STEEL	E-COAT	N/A	20 BULK	B

NB = No Bushing.



C Satin Stainless Steel



D Satin Stainless Steel



E Polished Stainless Steel



F E-Coat Mild Steel



G E-Coat Mild Steel



Welded 3/4 x 10 stainless steel nut

THREADED RECTANGULAR STEEL BASE



A Satin Stainless Steel



Threaded

Threaded rectangular bases, available in stainless steel or mild steel with a variety of finishes.

- 4" below deck needed
- Below deck mount (requires a 2-1/2" hole in deck)
- Welded stainless steel nut for optimal support



RETAIL IMAGE	PART NUMBER	BASE	MATERIAL	FINISH	BUSHING	PACK QUANTITY	ABYC
A	1630004	6" X 8"	STAINLESS STEEL	SATIN	NYLON	6 RETAIL	B

Retail packed in clamshell with 4-color label

OEM IMAGE	PART NUMBER	BASE	MATERIAL	FINISH	BUSHING	PACK QUANTITY	ABYC
A	3630004	6" X 8"	STAINLESS STEEL	SATIN	NYLON	20 BULK	B
B	3630004-B	6" X 8"	STAINLESS STEEL	SATIN	BRASS	20 BULK	B
C	3630004-BLK	6" X 8"	MILD STEEL	BLACK KRINKLE	NYLON	20 BULK	B
D	3630004-EC	6" X 8"	MILD STEEL	E-COAT	NYLON	20 BULK	B
E	3630004-ECB	6" X 8"	MILD STEEL	E-COAT	BRASS	20 BULK	B
F	3630005	4" X 8"	STAINLESS STEEL	SATIN	NYLON	20 BULK	B
G	3630005-PB	4" X 8"	STAINLESS STEEL	POLISHED	BRASS	20 BULK	B
H	3630006-PB	4" X 4"	STAINLESS STEEL	POLISHED	BRASS	20 BULK	B
I	3630007-NB	3" X 4"	STAINLESS STEEL	MILL	N/A	20 BULK	B
J	3630017-ECB	7" X 10"	MILD STEEL	E-COAT	BRASS	20 BULK	B
K	3630019	7" X 10"	STAINLESS STEEL	SATIN	BRASS	20 BULK	B

NB = No Bushing



B Satin Stainless Steel



C Black Krinkle Mild Steel



D E-Coat Mild Steel



E E-Coat Mild Steel



F Satin Stainless Steel



G Polished Stainless Steel



H Polished Stainless Steel



I Mill Stainless Steel



J Satin Stainless Steel



K Satin Stainless Steel

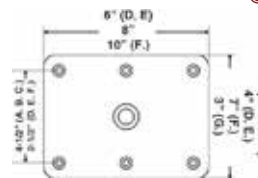

Welded 3/4 x 10 stainless steel nut

KINGPIN™ SERIES

STANDARD SQUARE ALUMINUM BASE



A

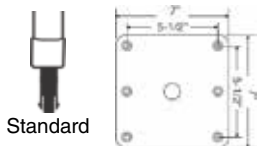

Standard

RETAIL IMAGE	PART NUMBER	BASE	MATERIAL	FINISH	BUSHING	PACK QUANTITY	ABYC
A	1620016	7" X 7"	ALUMINUM	SATIN	NYLON	6 RETAIL	B

Retail packed in clamshell with 4-color label

OEM IMAGE	PART NUMBER	BASE	MATERIAL	FINISH	BUSHING	PACK QUANTITY	ABYC
A	3620016	7" X 7"	ALUMINUM	SATIN	NYLON	20 BULK	B

High-strength cast aluminum, satin finish.

- 3" below deck needed
- Below deck mount (requires a 2-1/2" hole in deck)
- Use with any standard KingPin™ post (sold separately)



SQUARE COMPOSITE BASE

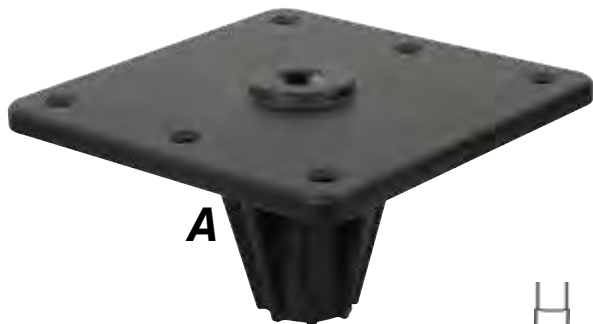

A

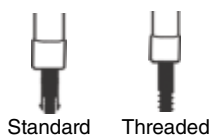

Standard

Threaded

OEM IMAGE	PART NUMBER	BASE	MATERIAL	FINISH	PACK QUANTITY	ABYC
A	3630010	7" x 7"	COMPOSITE	BLACK	20 BULK	B

High-strength robust 7" square base made of composite material, and accepts standard or threaded posts.

- Single piece acts as one solid bushing
- Use with any standard or threaded KingPin™ post (sold separately)



KINGPIN™ ROUND BASE



A

Satin 8" Round

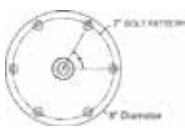

B

Polished 5" x 7" Oval



C

Polished 4" Round

RETAIL IMAGE	PART NUMBER	BASE	MATERIAL	PIN	FINISH	BUSHING	PACK QUANTITY	ABYC
A	1620017-S	8"	ALUMINUM	STANDARD	SATIN	NYLON	6 RETAIL	B

Retail packed in clamshell with 4-color label

OEM IMAGE	PART NUMBER	BASE	MATERIAL	PIN	FINISH	BUSHING	PACK QUANTITY	ABYC
A	3620017-SB	8"	ALUMINUM	STANDARD	SATIN	NYLON	20 BULK	B
B	3620024	5" X 7" OVAL	STAINLESS STEEL	STANDARD	POLISHED	NYLON	20 BULK	B
B	3630024	5" X 7" OVAL	STAINLESS STEEL	THREADED	POLISHED	NYLON	20 BULK	B
C	3620025	4"	STAINLESS STEEL	STANDARD	POLISHED	NYLON	20 BULK	B
C	3630025	4"	STAINLESS STEEL	THREADED	POLISHED	NYLON	20 BULK	B

Round bases available in satin or polished finish.

- Below deck mount (requires a 2-1/2" hole in deck)
- Use with any standard or threaded KingPin™ post (sold separately)



KINGPIN™ ACCESSORIES



A Provide convenient place to store your post when not in use (sold in pairs as shown)



B Inserts into Taper-Lock™ base to accept KingPin™ pedestals



C Nylon replacement bushing for KingPin™ base

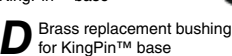

D Brass replacement bushing for KingPin™ base



E Base socket cover



F Plastic KingPin™ Retention Clip

RETAIL IMAGE	PART NUMBER	DESCRIPTION	PACK QUANTITY
A	2100026	1-3/4" STOWABLE POST CLIPS	6 RETAIL
B	2100032	TAPER-LOCK™ ADAPTER	6 RETAIL
C	2100055	NYLON KINGPIN™ BUSHING	6 RETAIL
D	2100077	BRASS KINGPIN™ BUSHING	6 RETAIL
E	2100094	BASE SOCKET COVER	6 RETAIL
F	2100175	KINGPIN™ RETENTION CLIP	6 RETAIL

OEM IMAGE	PART NUMBER	DESCRIPTION	PACK QUANTITY
C	2100055-M	NYLON KINGPIN™ BUSHING	120 BULK
G	3620760	SPLASH GUARD FOR KINGPIN™ BASE	20 BULK

Installed on base below deck to prevent water from entering into compartments below

- SEAT MOUNTS
- PEDESTALS
- BASES
- ACCESSORIES
- PACKAGES

Taper-Lock™

Experience Unmatched Stability with **SPRINGFIELD Marine's** Taper-Lock™ System!

Imagine hitting the water with the most stable and secure seating system available. Since 1982, **SPRINGFIELD Marine's** Taper-Lock™ pedestal system has been a game-changer, with over one million units sold! Designed for versatility and unmatched stability, the Taper-Lock™ features a high-strength composite bushing that creates a snug, secure fit in the pedestal base. Plus, the locking tab prevents unwanted turning, keeping your seat firmly in place.

Perfect for fishing boats, the Taper-Lock™ system is trusted by top-name boat builders for its reliability and performance. Whether you're casting a line or navigating open waters, our Taper-Lock™ system ensures a smooth and secure ride. Join the ranks of satisfied boaters and elevate your boating experience.



PRODUCTS IN THE TAPER-LOCK™ SERIES ARE DESIGNED FOR RECREATIONAL USE ONLY

TAPER-LOCK™ SERIES

2-PIECE POST PACKAGE



RETAIL IMAGE	PART NUMBER	DESCRIPTION	DIAMETER	PACK QUANTITY	ABYC
A	1600420	HI-LO 2-PIECE PACKAGE	2-3/8"	1 RETAIL	B
B	1600607	NON-LOCKING 2-PIECE PACKAGE	2-3/8"	1 RETAIL	AP
C	1600607-L	LOCKING 2-PIECE PACKAGE	2-3/8"	1 RETAIL	AD

Retail packed in box with 4-color label

Hi-Lo 2-Piece package (A) includes the following parts:

- Taper-Lock™ Hi-Lo anodized post
- Taper-Lock™ Hi-Lo swivel
- Use with any Taper-Lock™ base (sold separately)
- 16" from deck to top of swivel

2-Piece package (B & C) includes the following parts:

- Taper-Lock™ 13" anodized post
- Taper-Lock™ locking (C) or non-locking (B) 2-3/8" swivel
- Use with any Taper-Lock™ base (sold separately)

This Hi-Lo system allows for upright seating while fishing, compact in size for easy storage, and increases driver visibility while the boat is underway.



POWER-RISE STAND-UP POST



RETAIL IMAGE	PART NUMBER	DESCRIPTION	DIAMETER	ADJUSTS	PACK QUANTITY	ABYC
A	1602016	STAND-UP POST & MOUNT	2-3/8"	22-1/2" to 29-1/2"	1 RETAIL	B

Retail packed in box with 4-color label

Power-rise stand-up Taper-Lock™ post adjusts from 22-1/2" to 29-1/2" and rotates 360°.

- Universal seat mounting pattern: 5" x 5"
- Use with any Taper-Lock™ base
- Satin anodized post

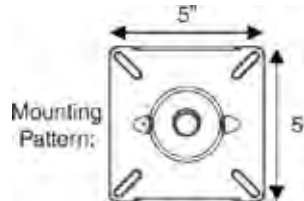

POWER-RISE SIT-DOWN POST



RETAIL IMAGE	PART NUMBER	DESCRIPTION	DIAMETER	ADJUSTS	PACK QUANTITY	ABYC
A	1601002-L	LOCKING PEDESTAL	2-3/8"	13-1/2" to 20"	1 RETAIL	B

Retail packed in clamshell with 4-color label

OEM IMAGE	PART NUMBER	DESCRIPTION	DIAMETER	ADJUSTS	PACK QUANTITY	ABYC
B	3601002	NON-LOCKING PEDESTAL	2-3/8"	13-1/2" to 20"	2 BULK	B
A	3601002-L	LOCKING PEDESTAL	2-3/8"	13-1/2" to 20"	2 BULK	B

Power-rise sit-down Taper-Lock™ post adjusts from 13-1/2" to 20" and rotates 360°.

- Use with any Taper-Lock™ base (sold separately)
- Cam prevents free spinning while trailering (on (A.) locking pedestal)
- Satin anodized post

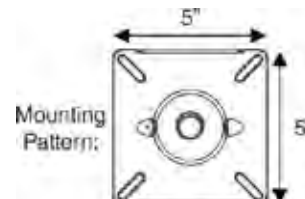

POWER-RISE STAND-UP PACKAGE

TAPER-LOCK™ SERIES



RETAIL IMAGE	PART NUMBER	DESCRIPTION	ADJUSTS	PACK QUANTITY	ABYC
A	1601037	POWER-RISE STAND-UP POST PKG	25-1/2" to 32-1/2"	1 RETAIL	B

Retail packed in box with 4-color label

Power-rise stand-up post package includes the following parts:

- Power-rise stand-up post (#1603013)
- Quik-tilt seat mount (#1615254-EC)
- Gray Pro Stand-Up seat (#1040213)
- Use with any Taper-Lock™ base (sold separately)
- Satin anodized post

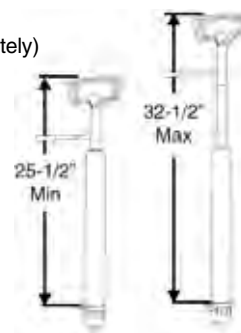

Use as seat or leaning post. Adjusts from 25-1/2" to 32-1/2" (add 2-3/4" height for seat mount, and 4-3/4" for seat thickness) Rotates 360°. Quik-tilt seat mount tilts in 4 snap-in angles (0°, 30°, 60°, 90°)

MANUAL ADJUSTABLE STAND-UP PKG



2 3/8" DIAMETER POST

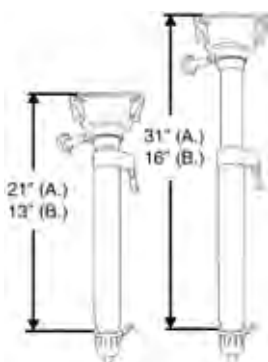

RETAIL IMAGE	PART NUMBER	ADJUSTS	DIAMETER	PACK QUANTITY	ABYC
A	1603824	21" to 31"	2-3/8"	1 RETAIL	B
B	1603825	13" to 16"	2-3/8"	1 RETAIL	B

Retail packed in box with 4-color label

OEM IMAGE	PART NUMBER	ADJUSTS	DIAMETER	PACK QUANTITY	ABYC
A	3603825-NS*	13" to 16"	2-3/8"	10 BULK	B

2-Piece package includes the following parts:

- 2-3/8" manual adjustable post (with posi-lock system)
- Trac-Lock™ non-locking 2-3/8" swivel (#1100031-1)
- Use with any Taper-Lock™ base (sold separately)
- Proprietary posi-lock system

* 3603825-NS and swivel sold separately



TRAC-LOCK™ SEAT MOUNT

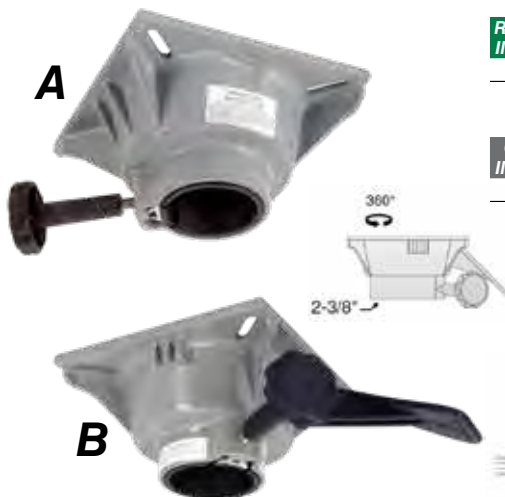

RETAIL IMAGE	PART NUMBER	DESCRIPTION	POST MOUNT	PACK QUANTITY	ABYC
A	1100031-1	NON-LOCKING TRAC-LOCK™ SEAT MOUNT	2-3/8"	6 RETAIL	AP
B	1100031-L1	LOCKING TRAC-LOCK™ SEAT MOUNT	2-3/8"	6 RETAIL	AD

Retail packed in clamshell with 4-color label

OEM IMAGE	PART NUMBER	DESCRIPTION	POST MOUNT	PACK QUANTITY	ABYC
A	3100031-1	NON-LOCKING TRAC-LOCK™ SEAT MOUNT	2-3/8"	20 BULK	AP
B	3100031-L1	LOCKING TRAC-LOCK™ SEAT MOUNT	2-3/8"	20 BULK	AD

High-strength aluminum with powder-coat finish that allows 360° rotation. Features a 2-3/8" post mount with busing for a snug fit.

- Locking, with centrally located handle, or non-locking swivel
- Adds 3/4" of height to pedestal.

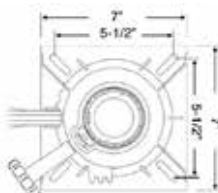

TAPER-LOCK™ SERIES

HI-LO SWIVEL

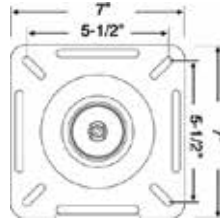

RETAIL IMAGE	PART NUMBER	DESCRIPTION	PACK QUANTITY	ABYC
A	1600205	HI-LO SWIVEL SEAT MOUNT	6 RETAIL	B

Retail packed in clamshell with 4-color label

Aluminum cast powder-coat finish.

- Use with any Taper-Lock™ Hi-Lo post (sold separately)
- Swivel adds 4" to height of post



TAPER-LOCK™ SERIES

FIXED HEIGHT HI-LO POST



2 3/8"
DIAMETER
POST

RETAIL IMAGE	PART NUMBER	FIXED HEIGHT	DIAMETER	PACK QUANTITY	ABYC
A	1600409	9"	2-3/8"	6 RETAIL	B
B	1600406	13"	2-3/8"	6 RETAIL	B

Retail packed in clamshell with 4-color label

OEM IMAGE	PART NUMBER	FIXED HEIGHT	DIAMETER	PACK QUANTITY	ABYC
A	3600409	9"	2-3/8"	20 BULK	B
B	3600406	13"	2-3/8"	20 BULK	B

Anodized aluminum post. Additional lengths available!

- Use with seat mount (#1600205, sold separately)
- Use with any Taper-Lock™ base (sold separately)



FIXED HEIGHT POST



2 3/8"
DIAMETER
POST

RETAIL IMAGE	PART NUMBER	DESCRIPTION	FIXED HEIGHT	PACK QUANTITY	ABYC
A	1600610	NON-LOCKING POST	13"	6 RETAIL	AP

Retail packed in clamshell with 4-color label

OEM IMAGE	PART NUMBER	DESCRIPTION	FIXED HEIGHT	PACK QUANTITY	ABYC
-	3600611-8	NON-LOCKING POST	11"	20 BULK	AP

Locking 2-3/8" post with anodized finish. Additional lengths available.

- Use with non-locking Trac-Lock™ swivel (sold separately)
- Use with any Taper-Lock™ base (sold separately)



9" ALUMINUM BASE

RETAIL IMAGE	PART NUMBER	SIZE	SHAPE	FINISH	PACK QUANTITY
B	1600003	9"	ROUND BASE	SATIN	6 RETAIL
C	1600005	9" X 7"	FLAT SIDE BASE	SATIN	6 RETAIL
D	1600008	9" X 5-1/8"	DOUBLE FLAT SIDE	SATIN	6 RETAIL
E	1600010	9"	ROUND SURFACE MOUNT	SATIN	6 RETAIL

Retail packed in clamshell with 4-color label

OEM IMAGE	PART NUMBER	SIZE	SHAPE	FINISH	PACK QUANTITY
A	3600002-AB	9"	ROUND BASE	ANODIZED	20 BULK
B	3600003	9"	ROUND BASE	SATIN	20 BULK
C	3600005	9" X 7"	FLAT SIDE BASE	SATIN	20 BULK
D	3600008	9" X 5-1/8"	DOUBLE FLAT SIDE	SATIN	20 BULK
E	3600010-FT	9"	ROUND SURFACE MOUNT	SATIN	20 BULK

High-strength aluminum to withstand all conditions. Flat side bases for limited space applications.

- Below deck mount (requires a 3.5" hole in deck)
- 8" mounting hole pattern
- Use with any Taper-Lock™ post (sold separately)



A



B



C



D

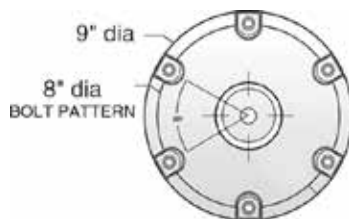

E

TAPER-LOCK™ SERIES

TAPER-LOCK™ ACCESSORIES

RETAIL IMAGE	PART NUMBER	DESCRIPTION	PACK QUANTITY
A	2100031	POWER PEDESTAL REPAIR KIT	6 RETAIL
B	2171003	SEAT SWIVEL BUSHING	6 RETAIL
C	2171004	POST BOTTOM BUSHING	6 RETAIL
D	2171032	2-3/8" HI-LO BUSHING	6 RETAIL
E	2171035	2" HI-LO BUSHING	6 RETAIL



A Power Pedestal Repair Kit



B Replacement Bushing for Taper-Lock™ Swivels



C Replacement Bushing for Taper-Lock™ Posts



D Bushing for 2-3/8" Hi-Lo Posts



E Bushing for Hi-Lo Fits 2" Posts

- SEAT MOUNTS
- PEDESTALS
- BASES
- ACCESSORIES
- PACKAGES

Plug-In™

SPRINGFIELD Marine's Plug-In™ removable pedestal series is designed for high durability and stability, using stainless steel hardware, high-strength aluminum, and engineering-grade plastics. The key features include:

- **Materials and Construction:** The series uses stainless steel, high-strength aluminum, and engineering-grade plastics to ensure the highest quality and durability.
- **Keyed Aluminum Anodized Post:** The high-strength anodized aluminum post fits into the base with inner and outer bushings, providing a clean look and sturdy function.
- **Notched and Keyed Design:** This unique design secures the post against rotation in the base and seat mount, ensuring stability and safety.
- **Stable Seating System:** Once engaged, the Plug-In™ system provides a stable and secure seating solution.
- **Versatility and Popularity:** The interlocking design makes it suitable for both freshwater and saltwater conditions, maintaining its popularity among removable pedestal systems for boats.

The Plug-In™ series is engineered to provide a robust and reliable seating system, ideal for rough marine environments.

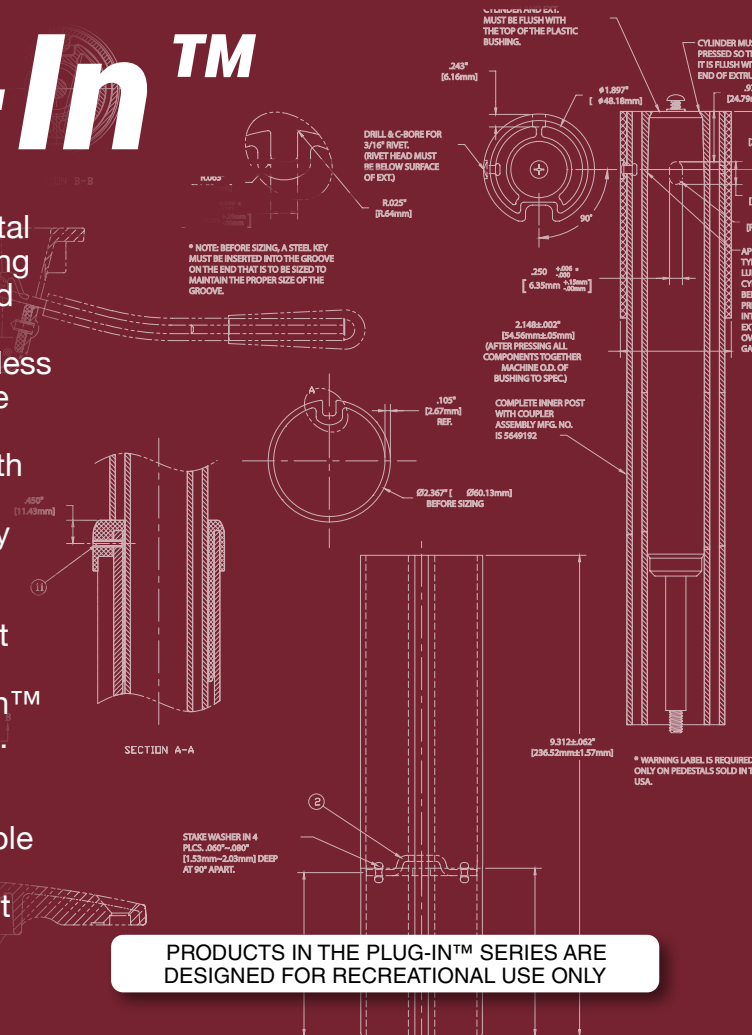

PRODUCTS IN THE PLUG-IN™ SERIES ARE DESIGNED FOR RECREATIONAL USE ONLY

3-PIECE PEDESTAL PACKAGE



RETAIL IMAGE	PART NUMBER	DESCRIPTION	HEIGHT	PACK QUANTITY	ABYC
A	1300709-HL1	HI-LO 3-PIECE PACKAGE	9"	1 RETAIL	B
A	1300712-HL1	HI-LO 3-PIECE PACKAGE	12"	1 RETAIL	B
A	1300715-HL1	HI-LO 3-PIECE PACKAGE	15"	1 RETAIL	B
B	1300709-L1	LOCKING 3-PIECE PACKAGE	9"	1 RETAIL	AD
B	1300712-L1	LOCKING 3-PIECE PACKAGE	12"	1 RETAIL	AD
B	1300715-L1	LOCKING 3-PIECE PACKAGE	15"	1 RETAIL	AD

Retail packed in box with 4-color label

Hi-Lo 3-piece package (A) includes the following parts:

- Plug-In™ Hi-Lo swivel seat mount (#1312701)
- Plug-In™ Hi-Lo fixed height post, anodized finish
- Plug-In™ 9" diameter base, satin finish (#1300751-1)

Locking 3-piece package (B) includes the following parts:

- Trac-Lock™ locking swivel seat mount (#1100031-L1)
- Plug-In™ fixed height post, anodized finish
- Plug-In™ 9" diameter base, satin finish (#1300750-1)



POWER-RISE STAND-UP POST PACKAGE



RETAIL IMAGE	PART NUMBER	DESCRIPTION	ADJUSTS	PACK QUANTITY	ABYC
A	1301037	3-PIECE POWER-RISE STAND-UP PKG	25-1/2" to 32-1/2"	1 RETAIL	B
A	1301038	2-PIECE POWER-RISE STAND-UP PKG	25-1/2" to 32-1/2"	1 RETAIL	B

Retail packed in box with 4-color label

High-strength aluminum pedestal adjusts from 25-1/2" to 32-1/2". Fits any 2-3/8" Plug-In™ base (sold separately).

3-Piece package (A) includes the following parts:

- Power-rise stand-up post (#1303013)
- Quik-tilt seat mount (#1615254-EC)
- Gray Pro stand-up seat (#1040213)

2-Piece package (B) includes the following parts:

- Power-rise stand-up post (#1303013)
- Quik-tilt seat mount (#1615254-EC)



POWER-RISE AIR-RIDE POST

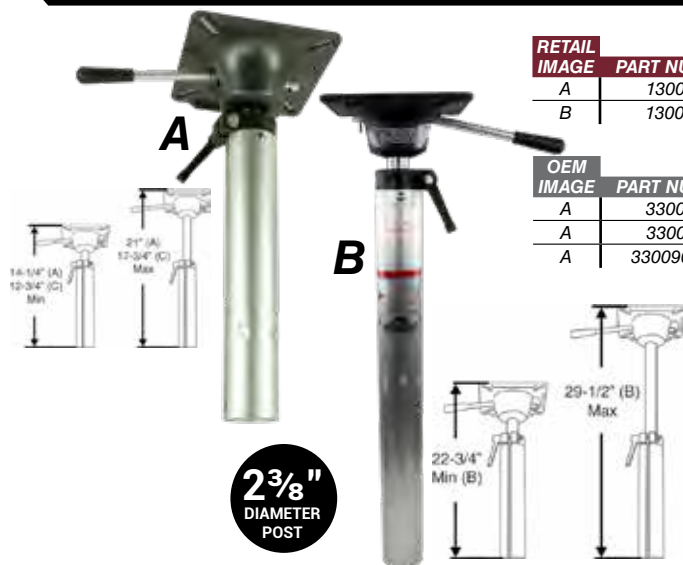

RETAIL IMAGE	PART NUMBER	DESCRIPTION	ADJUSTS	PACK QUANTITY	ABYC
A	1300901	LOCKING AIR-RIDE POST	14-1/4" to 21"	1 RETAIL	B
B	1300902	LOCKING AIR-RIDE POST	22-1/4" to 29-1/2"	1 RETAIL	B

Retail packed in clamshell with 4-color label

OEM IMAGE	PART NUMBER	DESCRIPTION	ADJUSTS	PACK QUANTITY	ABYC
A	3300900	LOCKING AIR-RIDE POST	12-3/4" to 17-3/4"	2 BULK	B
A	3300901	LOCKING AIR-RIDE POST	14-1/4" to 21"	2 BULK	B
A	3300902-AS	LOCKING AIR-RIDE POST W/SLEEVE	22-3/4" to 29"	2 BULK	B

Anodized aluminum post can be locked in position to prevent rotating or unlocked to rotate freely. Provides safe stable seating. Fits any 2-3/8" Plug-In™ base (sold separately)

- Case aluminum seat mount with black textured powder-coated finish
- 5" x 5" bolt pattern
- 3° Degree tilt
- Aluminum-capped gas cylinder inner post



PLUG-IN™ SERIES

POWER-RISE AIR-RIDE PACKAGE

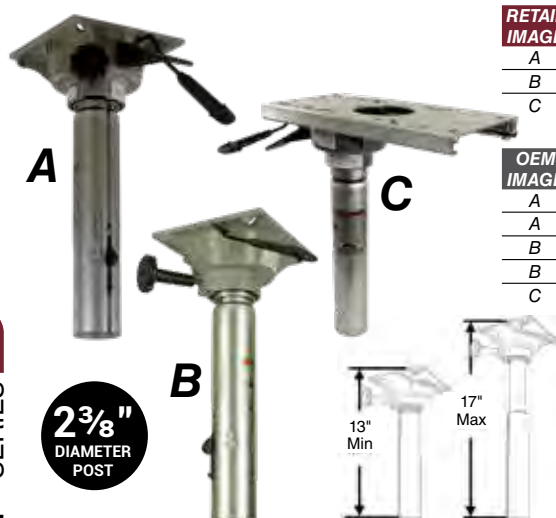

RETAIL					
IMAGE	PART NUMBER	DESCRIPTION	ADJUSTS	PACK QUANTITY	ABYC
A	1300601	LOCKING TRAC-LOCK™ SWIVEL	13" to 17"	1 RETAIL	AD
B	1300601-AP	NON-LOCKING TRAC-LOCK™ SWIVEL	13" to 17"	1 RETAIL	AP
C	1300650-L	PLUG-IN™ AIR-RIDE PEDESTAL W/SLIDE	13-1/2" to 17-1/2"	1 RETAIL	AD

Retail packed in box with 4-color label

OEM					
IMAGE	PART NUMBER	DESCRIPTION	ADJUSTS	PACK QUANTITY	ABYC
A	3300601	LOCKING TRAC-LOCK™ SWIVEL	13" to 17"	2 BULK	AD
A	3300601-01	LOCKING TRAC-LOCK™ SWIVEL	13" to 17"	2 BULK	AD
B	3300601-AP	NON-LOCKING TRAC-LOCK™ SWIVEL	13" to 17"	2 BULK	AP
B	3300601-AP01	NON-LOCKING TRAC-LOCK™ SWIVEL	13" to 17"	2 BULK	AP
C	3300651-01L	PLUG-IN™ AIR-RIDE PEDESTAL W/SLIDE	13-1/2" to 17-1/2"	2 BULK	AD

High-strength aluminum post. Fits any 2-3/8" Plug-In™ base (sold separately).
 • Includes Trac-Lock™ locking or non-locking air-ride swivel.



TRAC-LOCK™ SEAT MOUNT

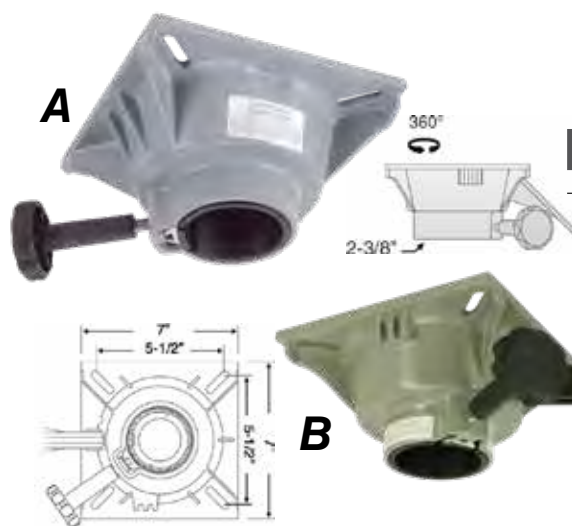

RETAIL				
IMAGE	PART NUMBER	DESCRIPTION	PACK QUANTITY	ABYC
A	1100031-1	NON-LOCKING 2-3/8" TRAC-LOCK™ SWIVEL	6 RETAIL	AP
B	1100031-L1	LOCKING 2-3/8" TRAC-LOCK™ SWIVEL	6 RETAIL	AD

Retail packed in clamshell with 4-color label

OEM				
IMAGE	PART NUMBER	DESCRIPTION	PACK QUANTITY	ABYC
A	3100031-1	NON-LOCKING 2-3/8" TRAC-LOCK™ SWIVEL	20 BULK	AP
B	3100031-L1	LOCKING 2-3/8" TRAC-LOCK™ SWIVEL	20 BULK	AD

High-strength aluminum with powder-coated finish. Rotates 360°, 2-3/8" post mount with bushing for snug fit.
 • Locking with centrally located locking handle, or non-locking swivel
 • Adds 3/4" to height of pedestal



HI-LO PLUG-IN™ SEAT MOUNT



RETAIL					
IMAGE	PART NUMBER	DESCRIPTION	PIN	PACK QUANTITY	ABYC
A	1312701	PLUG-IN™ HI-LO SWIVEL	5"	6 RETAIL	B

Retail packed in clamshell with 4-color label

OEM					
IMAGE	PART NUMBER	DESCRIPTION	PIN	PACK QUANTITY	ABYC
A	3312701	PLUG-IN™ HI-LO SWIVEL	5"	20 BULK	B
B	3312701-PP	PLUG-IN™ HI-LO SWIVEL	5"	20 BULK	B

Pin fits into Hi-Lo post for seating or into Hi-Lo base for compact storage.
 • Hi-Lo swivel adds 1-3/4" to height of post
 • Available in e-coat or stainless steel polished

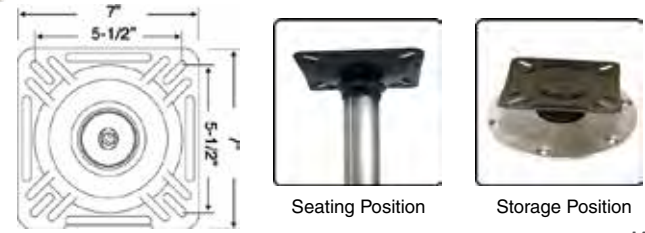

PLUG-IN™ SERIES

2-3/8" LOCKING FIXED HEIGHT POST

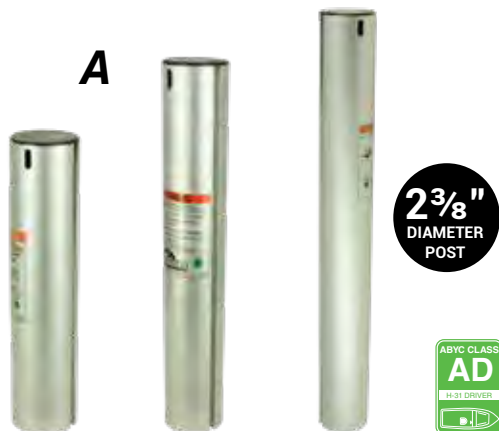

RETAIL IMAGE	PART NUMBER	DESCRIPTION	HEIGHT	PACK QUANTITY	ABYC
A	1300709	LOCKING POST	9"	6 RETAIL	AD
A	1300712	LOCKING POST	12"	6 RETAIL	AD
A	1300713	LOCKING POST	13"	6 RETAIL	AD
A	1300715	LOCKING POST	15"	6 RETAIL	AD
A	1300718	LOCKING POST	18"	6 RETAIL	AD
A	1300728	LOCKING POST	28"	6 RETAIL	AD

Retail packed in clamshell with 4-color label

OEM IMAGE	PART NUMBER	DESCRIPTION	HEIGHT	PACK QUANTITY	ABYC
A	3300709	LOCKING POST	9"	20 PACK	AD
A	3300710	LOCKING POST	10"	20 PACK	AD
A	3300712	LOCKING POST	12"	20 PACK	AD
A	3300713	LOCKING POST	13"	20 PACK	AD
A	3300714	LOCKING POST	14"	20 PACK	AD
A	3300715	LOCKING POST	15"	20 PACK	AD
A	3300718	LOCKING POST	18"	20 PACK	AD
A	3300728	LOCKING POST	28"	20 PACK	AD

Heights are from top of post to deck when post is installed. Anodized to withstand all conditions.

- Fits into any 2-3/8" Plug-In™ base (sold separately)
- Use with any 2-3/8" Trac-Lock™ swivel (sold separately), swivel adds 3/4" to height

2-3/8" LOCKING POST WITH LATCH



RETAIL IMAGE	PART NUMBER	DESCRIPTION	HEIGHT	FINISH	PACK QUANTITY	ABYC
A	1310712-L	LOCKING POST WITH LATCH	12"	ANODIZED	6 RETAIL	AD
A	1310715-L	LOCKING POST WITH LATCH	15"	ANODIZED	6 RETAIL	AD

Retail packed in box with 4-color label

OEM IMAGE	PART NUMBER	DESCRIPTION	HEIGHT	FINISH	PACK QUANTITY	ABYC
A	3310708-L	LOCKING POST WITH LATCH	8.5"	ANODIZED	20 BULK	AD
A	3310709-L	LOCKING POST WITH LATCH	9"	ANODIZED	20 BULK	AD
A	3310710-L	LOCKING POST WITH LATCH	10"	ANODIZED	20 BULK	AD
A	3310712-L	LOCKING POST WITH LATCH	12"	ANODIZED	20 BULK	AD
A	3310715-L	LOCKING POST WITH LATCH	15"	ANODIZED	20 BULK	AD
A	3310725-L	LOCKING POST WITH LATCH	25"	ANODIZED	20 BULK	AD

Heights are from top of post to deck when post is installed.

- Latch safely secures post to base
- Fits into any Plug-In™ base (sold separately)
- Use with any 2-3/8" Trac-Lock™ swivel (sold separately), swivel adds 3/4" to height



2-3/8" HI-LO POST

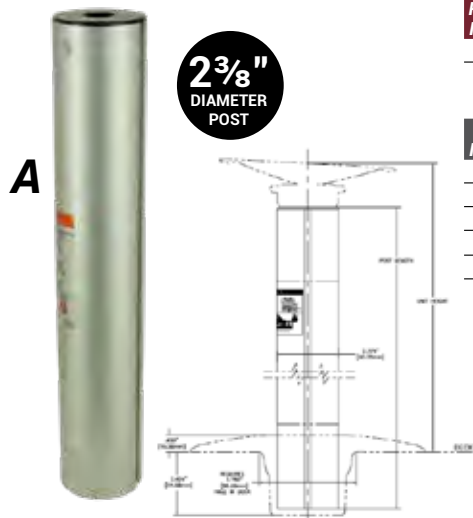

RETAIL IMAGE	PART NUMBER	DESCRIPTION	HEIGHT	FINISH	PACK QUANTITY	ABYC
A	1304012-HL	LOCKING POST WITH LATCH	12"	ANODIZED/ALUM	6 RETAIL	B
A	1304015-HL	LOCKING POST WITH LATCH	15"	ANODIZED/ALUM	6 RETAIL	B

Retail packed in clamshell with 4-color label

OEM IMAGE	PART NUMBER	DESCRIPTION	HEIGHT	FINISH	PACK QUANTITY	ABYC
A	3300709-HL	LOCKING POST WITH LATCH	9"	ANODIZED/ALUM	20 BULK	B
A	3300712-HL	LOCKING POST WITH LATCH	12"	ANODIZED/ALUM	20 BULK	B
A	3300713-HL	LOCKING POST WITH LATCH	13"	ANODIZED/ALUM	20 BULK	B
A	3300715-HL	LOCKING POST WITH LATCH	15"	ANODIZED/ALUM	20 BULK	B
A	3300724-HL	LOCKING POST WITH LATCH	24"	ANODIZED/ALUM	20 BULK	B
A	3300728-HL	LOCKING POST WITH LATCH	28"	ANODIZED/ALUM	20 BULK	B

Available in a variety of heights with high-strength anodized aluminum finish. Heights are from top of swivel to deck when post is installed.

- Use with Plug-In™ Hi-Lo seat mount (sold separately)
- Use with 2-3/8" Hi-Lo Plug-In™ base (sold separately)



PLUG-IN™ SERIES

ROUND BASE

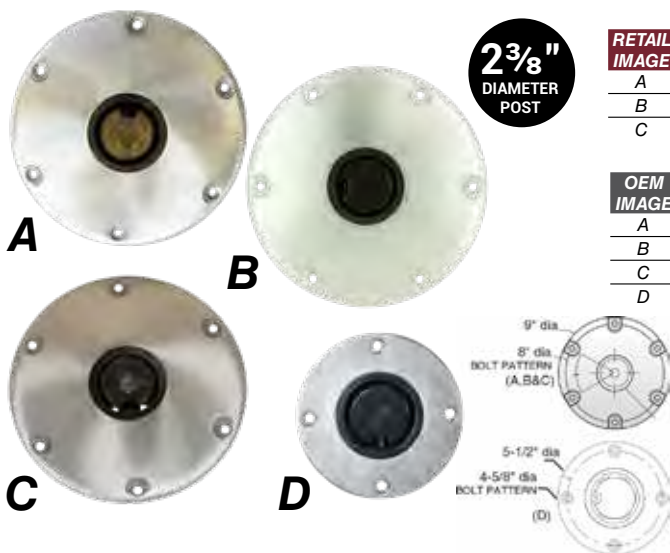

RETAIL IMAGE	PART NUMBER	DESCRIPTION	SIZE	FINISH	PACK QUANTITY
A	1300750-1	BASE	9"	SATIN	6 RETAIL
B	1300750-A1	BASE	9"	ANODIZED	6 RETAIL
C	1300751-1	HI-LO BASE	9"	SATIN	6 RETAIL

Retail packed in clamshell with 4-color label

OEM IMAGE	PART NUMBER	DESCRIPTION	SIZE	FINISH	PACK QUANTITY
A	3300750-1	BASE	9"	SATIN	20 BULK
B	3300750-A1	BASE	9"	ANODIZED	20 BULK
C	3300751-1	HI-LO BASE	9"	SATIN	20 BULK
D	3300764-PP1	BASE	5.5"	STAINLESS STEEL	20 BULK

Below deck mount requires a 3-3/4" hole in deck.

- Use with any 2-3/8" Plug-In™ post (sold separately)

FLAT-SIDED ALUMINUM BASE



RETAIL IMAGE	PART NUMBER	DESCRIPTION	FINISH	PACK QUANTITY
A	1300750-L1	LEFT FLAT-SIDED BASE	SATIN	6 RETAIL
B	1300750-R1	RIGHT FLAT-SIDED BASE	SATIN	6 RETAIL

Retail packed in clamshell with 4-color label

OEM IMAGE	PART NUMBER	DESCRIPTION	FINISH	PACK QUANTITY
A	3300750-L1	LEFT FLAT-SIDED BASE	SATIN	20 BULK
B	3300750-R1	RIGHT FLAT-SIDED BASE	SATIN	20 BULK
C	3300750-D1	DOUBLE FLAT-SIDED BASE	SATIN	20 BULK
A	3300750-AL1	LEFT FLAT-SIDED BASE	ANODIZED	20 BULK
B	3300750-AR1	RIGHT FLAT-SIDED BASE	ANODIZED	20 BULK
C	3300750-AD1	DOUBLE FLAT-SIDED BASE	ANODIZED	20 BULK

Available in satin or anodized finish. Use with any 2-3/8" Plug-In™ post (sold separately)

- Left Flat (A): 9" x 7", flat side is on same side as notch
- Right Flat (B): 9" x 7", flat side is on opposite side as notch
- Double Flat (C): 9" x 5-1/4", both sides are flat

SQUARE AND RECTANGLE BASE

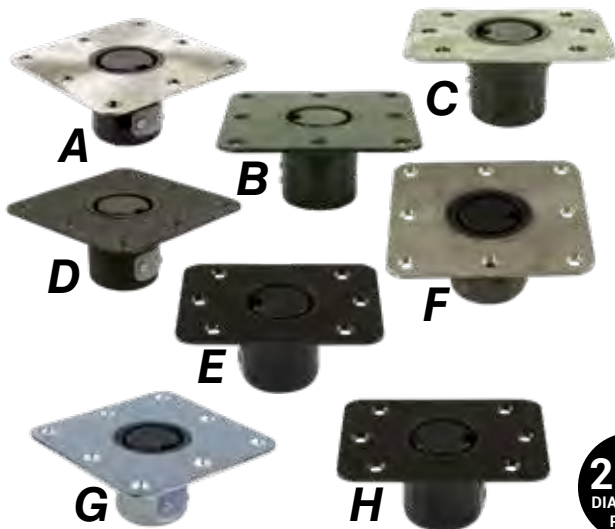

RETAIL IMAGE	PART NUMBER	MATERIAL	SIZE	FINISH	PACK QUANTITY
A	1300754-1	STAINLESS STEEL	7" x 7"	SATIN	1 RETAIL

Retail packed in clamshell with 4-color label

OEM IMAGE	PART NUMBER	MATERIAL	SIZE	FINISH	PACK QUANTITY
B	3300753-1	MILD STEEL	7" x 7"	E-COAT	20 BULK
C	3300752-D	STAINLESS STEEL	5" x 7"	E-COAT/SATIN	20 BULK
D	3300753-K1	MILD STEEL	7" x 7"	BLACK KRINKLE	20 BULK
A	3300754-1	STAINLESS STEEL	7" x 7"	SATIN	20 BULK
E	3300757-D1	MILD STEEL	5" x 7"	E-COAT	20 BULK
F	3300758-1	STAINLESS STEEL	7" x 7"	MILL	20 BULK
G	3300759-PP1	STAINLESS STEEL	7" x 7"	POLISHED	20 BULK
H	3300757-DK1	MILD STEEL	5" x 7"	BLACK KRINKLE	20 BULK

Made of stainless or mild steel. Below deck mount requires a 3-3/4" hole in deck.

- Suitable for above or under carpet applications
- Use with any 2-3/8" Plug-In™ post (sold separately)

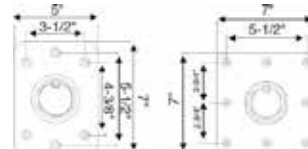

2-7/8" TRAC-LOCK™ SWIVEL



RETAIL IMAGE	PART NUMBER	DESCRIPTION	DIAMETER	PACK QUANTITY	ABYC
A	1100021-L1	LOCKING TRAC-LOCK™ SWIVEL	2-7/8"	6 RETAIL	AD

Retail packed in clamshell with 4-color label

OEM IMAGE	PART NUMBER	DESCRIPTION	DIAMETER	PACK QUANTITY	ABYC
A	3100021-L1	LOCKING TRAC-LOCK™ SWIVEL	2-7/8"	20 BULK	AD

High-strength aluminum with powder-coated finish. Post mount with bushing for snug fit.

- Locking with centrally located locking handle



2-7/8" LOCKING FIXED-HEIGHT POST



OEM IMAGE	PART NUMBER	DESCRIPTION	DIAMETER	HEIGHT	PACK QUANTITY	ABYC
A	3301809	LOCKING POST	2-7/8"	9"	20 BULK	AD
-	3301812	LOCKING POST	2-7/8"	12"	20 BULK	AD
-	3301815	LOCKING POST	2-7/8"	15"	20 BULK	AD
-	3301818	LOCKING POST	2-7/8"	18"	20 BULK	AD
-	3311821	LOCKING POST	2-7/8"	21"	20 BULK	AD
-	3301830	LOCKING POST	2-7/8"	30"	20 BULK	AD

Anodized finish to withstand all conditions. Heights are from top of post to deck when post is installed.

- Use with any 2-7/8" Trac-Lock™ locking swivel (sold separately), swivel adds 3/4" to height
- Fits into 2-7/8" Plug-In™ base (sold separately)



9" ROUND 2-7/8" BASE



OEM IMAGE	PART NUMBER	DESCRIPTION	DIAMETER	FINISH	PACK QUANTITY	ABYC
A	3300850-A1	ROUND PLUG-IN™ BASE	2-7/8"	ANODIZED	20 BULK	AD

High-strength aluminum with anodized finish. Fits any 2-7/8" Plug-In™ post (sold separately).

- Includes splash guard installed

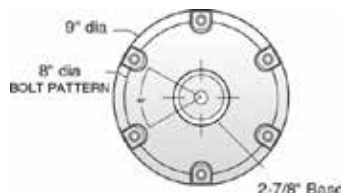

PLUG-IN™ ACCESSORIES



OEM IMAGE	PART NUMBER	DESCRIPTION	PACK QUANTITY
A	3300760	2-3/8" SPLASH GUARD	20 BULK
B	3300766	2-3/8" HI-LO REPLACEMENT BUSHING	20 BULK

2-3/8" Aluminum Splash Guard

2-3/8" Hi-Lo Replacement Bushing

- SEAT MOUNTS
- PEDESTALS
- BASES
- ACCESSORIES
- PACKAGES

Thread-Lock™

SPRINGFIELD Marine initially introduced the Thread-Lock™ as a table system. This innovative approach led to the adaptation of their post-style grill, utilizing the same attachment method. The success of these products paved the way for redesigning the post and base for use as a seating system, integrating a locking mechanism in the seat post to ensure a secure, wobble-free experience for both fishing and underway models. All while not going below deck, the surface mount system allows for easy installation.

The Thread-Lock™ systems feature interchangeable parts, allowing for the seamless use of seat bases with the grill or table. This versatility makes it an ideal choice for a fishing deck—simply remove the seating post, install the grill or table, and enjoy (note: the seat post will not fit into the table base).

With the Thread-Lock™ system, attaching the post to the base is as easy as twisting in a light bulb. The locking collar provides peace of mind, ensuring that your post remains securely attached to the base.

PRODUCTS IN THE THREAD-LOCK™ SERIES ARE DESIGNED FOR RECREATIONAL USE ONLY

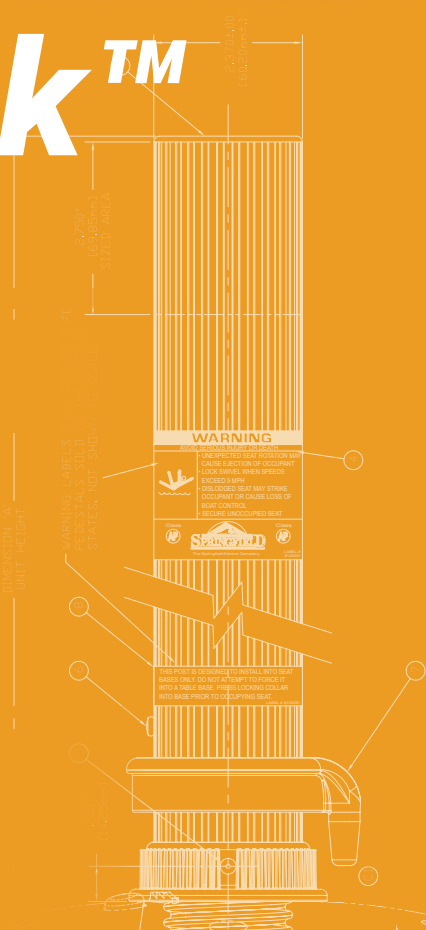

3-PIECE PEDESTAL PACKAGE

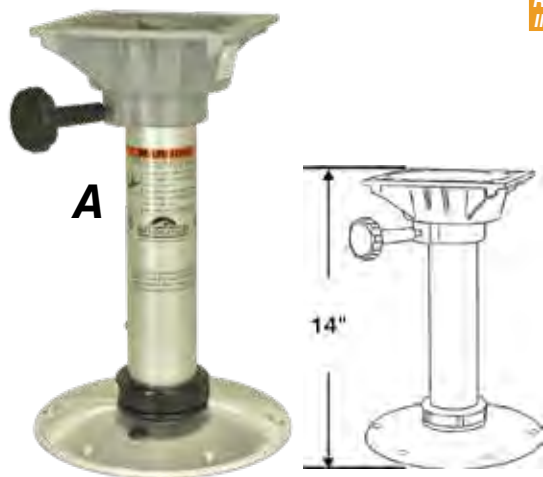

RETAIL IMAGE	PART NUMBER	DESCRIPTION	HEIGHT	PACK QUANTITY	ABYC
A	1793313	3-PIECE PACKAGE	14"	1 RETAIL	AP

Retail packed in clamshell with 4-color label

ABYC rated for use while underway, 3-piece set includes the following parts:

- Thread-Lock™ 13" fixed-height post (#3793013-A)
- Trac-Lock™ non-locking swivel seat mount (#1100031-1)
- Thread-Lock™ base



2 3/8"
DIAMETER
POST

TRAC-LOCK™ SEAT MOUNT



RETAIL IMAGE	PART NUMBER	DESCRIPTION	DIAMETER	PACK QUANTITY	ABYC
A	1100031-1	NON-LOCKING SEAT MOUNT	2-3/8"	6 RETAIL	AP

Retail packed in clamshell with 4-color label

OEM IMAGE	PART NUMBER	DESCRIPTION	DIAMETER	PACK QUANTITY	ABYC
A	3100031-1	NON-LOCKING SEAT MOUNT	2-3/8"	20 BULK	AP

High-strength aluminum with powder-coat finish. Adds 3/4" of height to pedestal.

- Swivel rotates 360°
- Use with 2-3/8" fixed-height post (for underway)



2 3/8"
DIAMETER
POST

HI-LO KINGPIN™ SEAT MOUNT

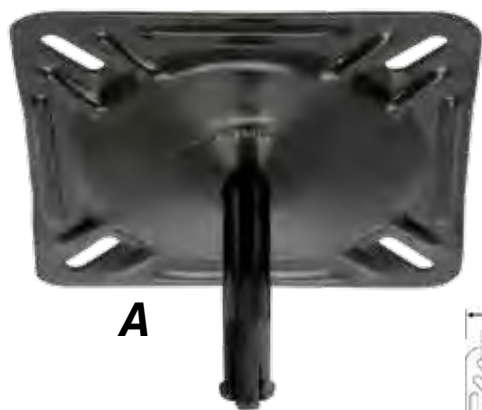

RETAIL IMAGE	PART NUMBER	DESCRIPTION	FINISH	PACK QUANTITY	ABYC
A	1615204-EC	SEAT MOUNT, NO SPRING	E-COAT	6 RETAIL	B

Retail packed in clamshell with 4-color label

OEM IMAGE	PART NUMBER	DESCRIPTION	FINISH	PACK QUANTITY	ABYC
A	3615204-EC	SEAT MOUNT, NO SPRING	E-COAT	20 BULK	B

Unintentional detachment to comply with ABYC.

- 7" x 7" swivel rotates 360°
- Use with Hi-Lo Thread-Lock™ fixed-height posts (for fishing only)



2 3/8"
DIAMETER
POST

THREAD-LOCK™ SERIES

FIXED-HEIGHT POST



A

OEM IMAGE	PART NUMBER	DIAMETER	HEIGHT	FINISH	PACK QUANTITY	ABYC
A	3793010-A	2-3/8"	10"	ANODIZED	20 BULK	AP
A	3793012-A	2-3/8"	12"	ANODIZED	20 BULK	AP
A	3793013-A	2-3/8"	13"	ANODIZED	20 BULK	AP

Sturdy 2-3/8" high-strength aluminum post for use while underway. Locking collar prevents unintentional removal from base.

- Use with Trac-Lock™ non-locking seat mount (sold separately)



HI-LO FIXED HEIGHT POST



A

OEM IMAGE	PART NUMBER	DIAMETER	HEIGHT	FINISH	PACK QUANTITY	ABYC
A	3793213	2-3/8"	13"	ANODIZED	20 BULK	B

Sturdy 2-3/8" high-strength aluminum post, anodized finish. Bottom locking collar prevents unintentional removal from base.

- Use with KingPin™ seat mount (sold separately)
- Use with any Thread-Lock™ base (for fishing only, sold separately)



ALUMINUM BASE



A

OEM IMAGE	PART NUMBER	DIAMETER	FINISH	PACK QUANTITY	ABYC
A	3796010-AL	10" BASE	ANODIZED	20 BULK	AP

High-strength aluminum bases, no hole in deck required.

- Use with any Thread-Lock™ fixed-height post (sold separately)
- Can be used with Thread-Lock™ table and grill posts (sold separately)



Thread-Lock™ seating bases can be used with Thread-Lock™ Grill and Table systems. DO NOT USE SEATING POSTS IN BASES MADE FOR GRILLS or TABLES.

THREAD-LOCK™ ACCESSORIES



Top View of Socket Cover



Bottom View of Socket Cover

RETAIL IMAGE	PART NUMBER	MATERIAL	PACK QUANTITY
A	2100092	PLASTIC BASE SOCKET COVER	6 RETAIL

OEM IMAGE	PART NUMBER	MATERIAL	PACK QUANTITY
A	2100092-B	PLASTIC BASE SOCKET COVER	20 BULK

Plastic base socket cover keeps socket clear when not in use.

- Fits any Thread-Lock™ base

- SEAT MOUNTS
- PEDESTALS
- BASES
- ACCESSORIES
- PACKAGES

Spring-Lock™

SPRINGFIELD Marine's Spring-Lock™ system is the world's first push-button activated pedestal, designed in response to industry demand. This system features a high-strength stainless steel post for long-lasting durability.

The Spring-Lock™ pedestals combine a sturdy and secure ride with the convenience of quick post removal. The locking latch extends from the post, securing it in the base. With a push of the button, the latch unlocks, allowing for easy post removal.

For an even simpler solution, **SPRINGFIELD Marine** offers the Clip-Lock system, delivering enhanced performance and ease of use. The base captures the end of the post, providing the necessary strength to keep it in place during intense freshwater action. To use, simply plug the Clip-Lock into the base. When finished, a simple pull on the post removes it from the base with ease.

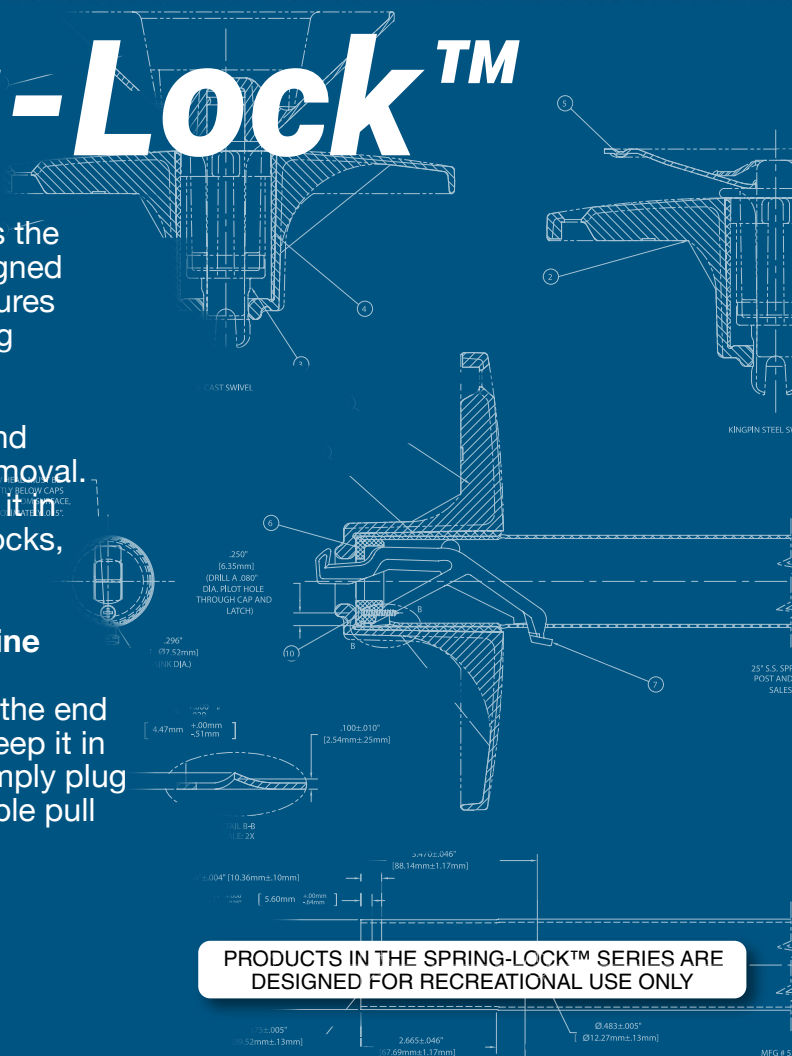

PRODUCTS IN THE SPRING-LOCK™ SERIES ARE DESIGNED FOR RECREATIONAL USE ONLY

SPRING-LOCK™ SERIES

CLIP-LOCK 3-PIECE PACKAGE

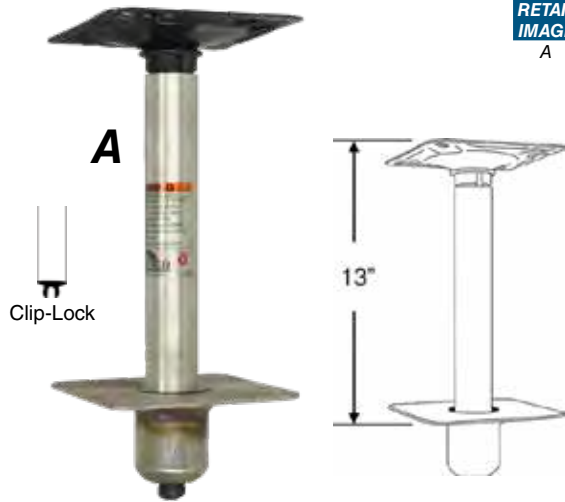

RETAIL IMAGE	PART NUMBER	DESCRIPTION	PACK QUANTITY	ABYC
A	1644513-S	3-PIECE NON-LOCKING PACKAGE	1 RETAIL	B

Retail packed in box with 4-color label

- 3-Piece package includes the following parts:
- 13" Clip-Lock non-locking post (#3640513)
 - Spring-Lock™ non-locking swivel (#3640202)
 - 7" x 7" non-locking square base (#3640013-CL)



POWER-RISE ADJUSTABLE SIT-DOWN POST

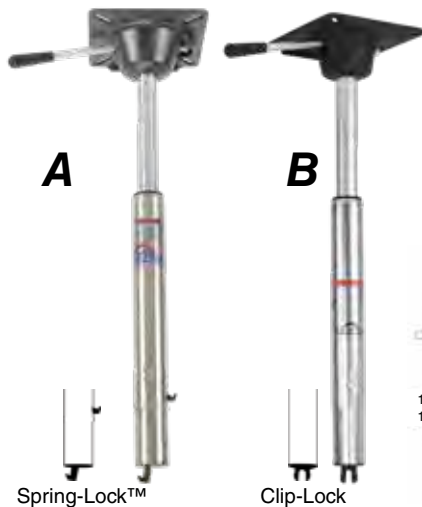

RETAIL IMAGE	PART NUMBER	MATERIAL	ADJUSTS	FINISH	PACK QUANTITY	ABYC
A	1642005	STAINLESS STEEL	15" to 21-1/2"	POLISHED	1 RETAIL	B

Retail packed in clamshell with 4-color label

OEM IMAGE	PART NUMBER	MATERIAL	ADJUSTS	FINISH	PACK QUANTITY	ABYC
A	3641007	STAINLESS STEEL	15" to 21-1/2"	POLISHED	2 BULK	B
A	3641013	STAINLESS STEEL	13-1/2" to 18"	POLISHED	2 BULK	B
B	3642507-BAS	ALUMINUM	16" to 22-1/2"	BRITE DIP	2 BULK	B

Spring-Lock™ (A) sit-down post has an adjustable height from 13-1/2" to 20" (unless noted).

- 3° tilt cast aluminum swivel, rotates 360°
- Use with any non-locking Spring-Lock™ base (sold separately)

Clip-Lock (B) sit-down post has an adjustable height from 16" to 22-1/2".

- 3° tilt cast aluminum swivel, rotates 360°
- Use with any non-locking Spring-Lock™ base (sold separately)
- Brite dip anodized post



POWER-RISE ADJUSTABLE STAND-UP POST

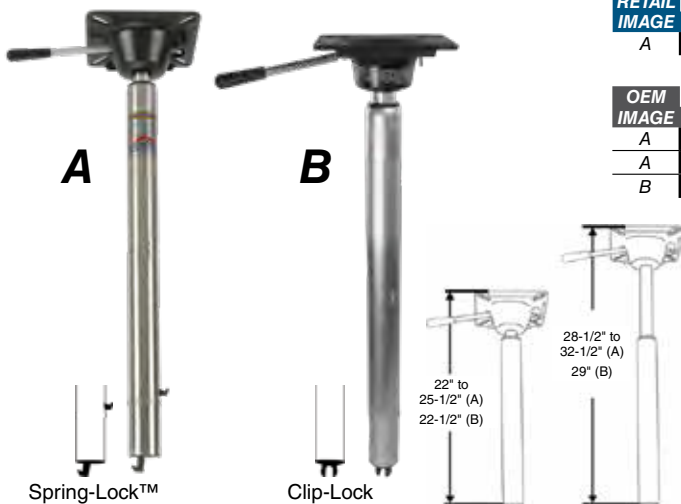

RETAIL IMAGE	PART NUMBER	MATERIAL	ADJUSTS	FINISH	PACK QUANTITY	ABYC
A	1642008	STAINLESS STEEL	22" to 28-1/2"	POLISHED	1 RETAIL	B

Retail packed in clamshell with 4-color label

OEM IMAGE	PART NUMBER	MATERIAL	ADJUSTS	FINISH	PACK QUANTITY	ABYC
A	1641009	STAINLESS STEEL	22" to 28-1/2"	POLISHED	1 BULK	B
A	1641019	STAINLESS STEEL	25-1/2" to 32-1/2"	POLISHED	1 BULK	B
B	3641508-AS	ALUMINUM	22-1/2" to 29"	ANODIZED	1 BULK	B

Spring-Lock™ (A) stand-up post has adjustable height.

- 3° tilt cast aluminum swivel, rotates 360°
- Use with any non-locking Spring-Lock™ base (sold separately)

Clip-Lock (B) stand-up post has an adjustable height from 22-1/2" to 29".

- 3° tilt cast aluminum swivel, rotates 360°
- Use with any non-locking Spring-Lock™ base (sold separately)



POWER-RISE STAND-UP PACKAGE

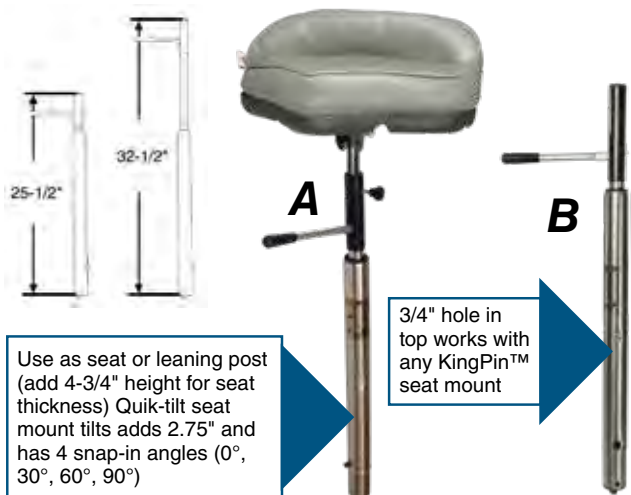

Use as seat or leaning post (add 4-3/4" height for seat thickness) Quik-tilt seat mount tilts adds 2.75" and has 4 snap-in angles (0°, 30°, 60°, 90°)

3/4" hole in top works with any KingPin™ seat mount

RETAIL IMAGE	PART NUMBER	DESCRIPTION	FINISH	PACK QUANTITY	ABYC
A	1641037	POWER-RISE STAND-UP PACKAGE		1 RETAIL	B
B	1643013	POWER-RISE STAND-UP POST		1 RETAIL	B

Retail packed in box with 4-color label

3-Piece package (A) includes the following parts:

- Power-rise stand-up post (#1643013)
- Quik-tilt seat mount (#1615254-EC)
- Gray pro stand-up seat (#1040213)



Stainless Steel post (#1643013) adjusts from 26-5/16" to 33-5/16". Use with any non-locking Spring-Lock™ base (sold separately)



NON-LOCKING SEAT MOUNT

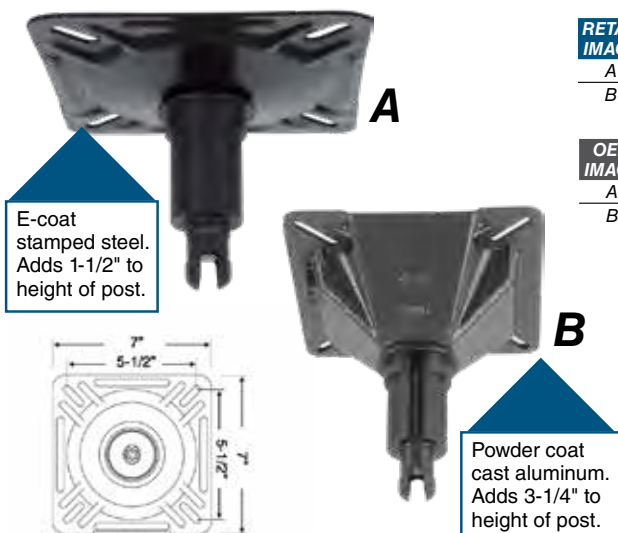

E-coat stamped steel. Adds 1-1/2" to height of post.

Powder coat cast aluminum. Adds 3-1/4" to height of post.

RETAIL IMAGE	PART NUMBER	DESCRIPTION	FINISH	PACK QUANTITY	ABYC
A	1640202	SPRING-LOCK™ SEAT MOUNT	E-COAT	1 RETAIL	B
B	1640203	HI-RISE SEAT MOUNT	POWDER-COAT	1 RETAIL	B

Retail packed in clamshell with 4-color label

OEM IMAGE	PART NUMBER	DESCRIPTION	FINISH	PACK QUANTITY	ABYC
A	3640202	SPRING-LOCK™ SEAT MOUNT	E-COAT	20 BULK	B
B	3640203	HI-RISE SEAT MOUNT	POWDER-COAT	20 BULK	B

E-coat or powder-coated finish to resist corrosion. Use with any Spring-Lock™ or Clip-Lock non-locking post (sold separately).



LOCKING SEAT MOUNT

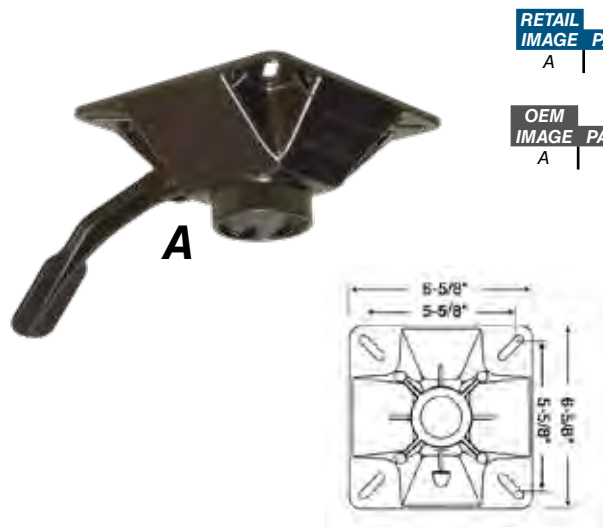

RETAIL IMAGE	PART NUMBER	DESCRIPTION	FINISH	PACK QUANTITY	ABYC
A	1680203	LOCKING SPRING-LOCK™ SEAT MOUNT	POWDER-COAT	1 RETAIL	AD

Retail packed in clamshell with 4-color label

OEM IMAGE	PART NUMBER	DESCRIPTION	FINISH	PACK QUANTITY	ABYC
A	3680203	LOCKING SPRING-LOCK™ SEAT MOUNT	POWDER-COAT	20 BULK	AD

Powder-coat finish to resist corrosion.

- Use with any locking Spring-Lock™ post (sold separately)
- Swivel adds 1/4" to height of pedestal



SPRING-LOCK™ SERIES

SPRING-LOCK™ NON-LOCKING POST

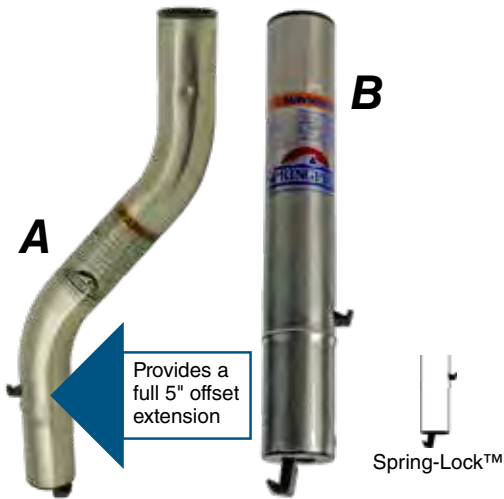

RETAIL IMAGE	PART NUMBER	DESCRIPTION	HEIGHT	PACK QUANTITY	ABYC
A	1640401	NON-LOCKING OFFSET POST	13-1/2"	6 RETAIL	B
B	1640411	NON-LOCKING POST	11-1/2"	6 RETAIL	B
B	1640404	NON-LOCKING POST	13-1/2"	6 RETAIL	B
B	1640403	NON-LOCKING POST	15-1/2"	6 RETAIL	B
B	1640425	NON-LOCKING POST	18"	6 RETAIL	B

Retail packed in clamshell with 4-color label

OEM IMAGE	PART NUMBER	DESCRIPTION	HEIGHT	PACK QUANTITY	ABYC
A	3640401	NON-LOCKING OFFSET POST	13-1/2"	20 BULK	B
B	3640411	NON-LOCKING POST	11-1/2"	20 BULK	B
B	3640413	NON-LOCKING POST	13-1/2"	20 BULK	B
B	3640415	NON-LOCKING POST	15-1/2"	20 BULK	B
B	3640425	NON-LOCKING POST	18"	20 BULK	B
B	3640430	NON-LOCKING POST	30"	20 BULK	B

Hefty 1-3/4" diameter stainless steel posts.

- Use with non-locking Spring-Lock™ seat mounts (sold separately)
- Use with any non-locking Spring-Lock™ base (sold separately)



SPRING-LOCK™ LOCKING POST

SPRING-LOCK™ SERIES

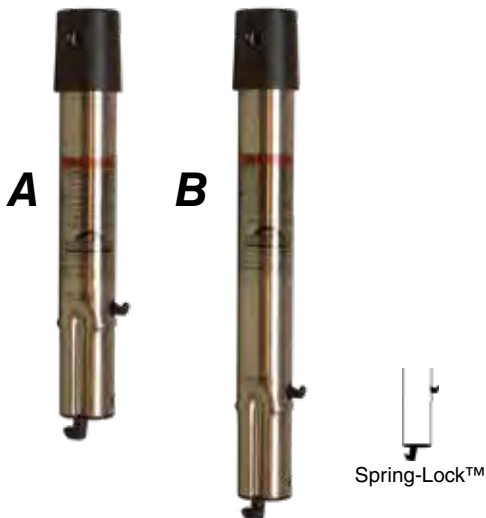

RETAIL IMAGE	PART NUMBER	DESCRIPTION	HEIGHT	PACK QUANTITY	ABYC
A	1680411	LOCKING SPRING-LOCK™ POST	11-1/4"	6 RETAIL	AD
B	1680415	LOCKING SPRING-LOCK™ POST	15-1/2"	6 RETAIL	AD

Retail packed in clamshell with 4-color label

OEM IMAGE	PART NUMBER	DESCRIPTION	HEIGHT	PACK QUANTITY	ABYC
A	3680411	LOCKING SPRING-LOCK™ POST	11-1/4"	20 BULK	AD
B	3680413	LOCKING SPRING-LOCK™ POST	13-1/2"	20 BULK	AD
B	3680415	LOCKING SPRING-LOCK™ POST	15-1/2"	20 BULK	AD
B	3680422	LOCKING SPRING-LOCK™ POST	22"	20 BULK	AD

Hefty 1-3/4" diameter stainless steel posts.

- Use with non-locking Spring-Lock™ seat mounts (sold separately)
- Use with any non-locking Spring-Lock™ base (sold separately)



CLIP-LOCK NON-LOCKING POST

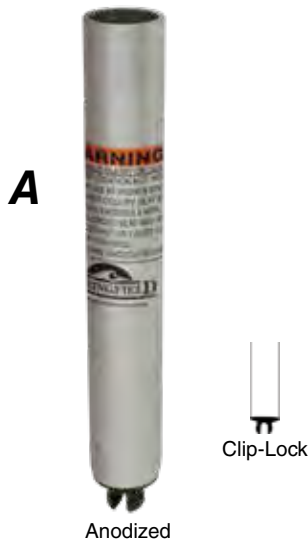

OEM IMAGE	PART NUMBER	DESCRIPTION	HEIGHT	FINISH	PACK QUANTITY	ABYC
A	3640511-A	NON-LOCKING POST	11"	ANODIZED	20 BULK	B
A	3640513-A	NON-LOCKING POST	13-1/2"	ANODIZED	20 BULK	B

Hefty 1-3/4" high-strength aluminum, available in anodized finish. Additional sizes available upon request.

- Use with non-locking Spring-Lock™ seat mounts (sold separately)
- Use with any non-locking Spring-Lock™ base (sold separately)



9" NON-LOCKING ROUND BASE

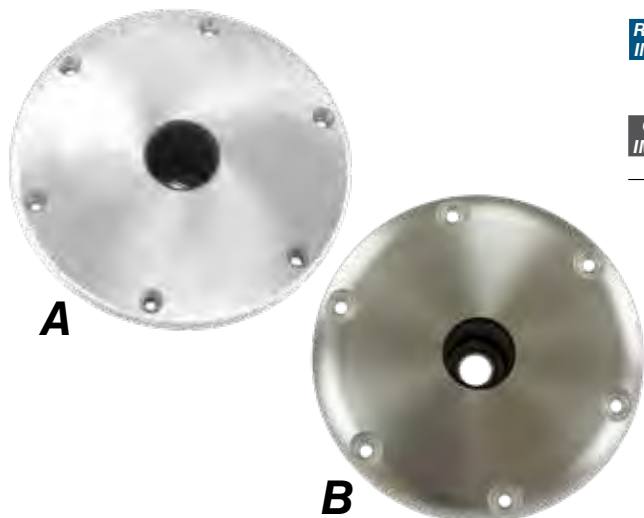

RETAIL IMAGE	PART NUMBER	DESCRIPTION	SIZE	FINISH	PACK QUANTITY	ABYC
A	1640002	NON-LOCKING BASE	9"	SATIN	6 RETAIL	B

Retail packed in clamshell with 4-color label

OEM IMAGE	PART NUMBER	DESCRIPTION	SIZE	FINISH	PACK QUANTITY	ABYC
A	3640002	NON-LOCKING BASE	9"	SATIN	20 BULK	B
B	3640002-CLA	NON-LOCKING BASE	9"	ANODIZED	20 BULK	B

High-strength aluminum with 8" hole pattern. Below deck mount requires a 4" hole in deck.

- Use with any Spring-Lock™ or Clip-Lock post (sold separately)



NON-LOCKING RECTANGULAR BASE

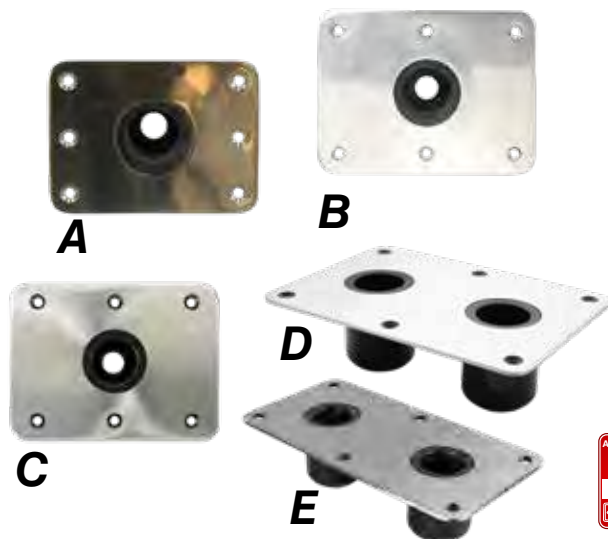

RETAIL IMAGE	PART NUMBER	MATERIAL	SIZE	FINISH	PACK QUANTITY	ABYC
C	1640024-CL	STAINLESS STEEL	6" x 8"	SATIN / E-COAT	6 RETAIL	B

Retail packed in clamshell with 4-color label

OEM IMAGE	PART NUMBER	MATERIAL	SIZE	FINISH	PACK QUANTITY	ABYC
A	3640022-PPCL	STAINLESS STEEL	5" x 7"	POLISHED	20 BULK	B
B	3640024-PPCL	STAINLESS STEEL	6" x 8"	POLISHED	20 BULK	B
C	3640024-CL	STAINLESS STEEL	6" x 8"	SATIN / E-COAT	20 BULK	B
D	3640025-CL	STAINLESS STEEL	7" x 10"	SATIN / E-COAT	20 BULK	B
E	3640028-CL	STAINLESS STEEL	6" x 12"	SATIN / E-COAT	20 BULK	B

Non-locking stainless steel base available in polished and satin / e-coated finishes.

- Below deck mount requires a 4" hole in deck
- Use with any Spring-Lock™ or Clip-Lock post (sold separately)

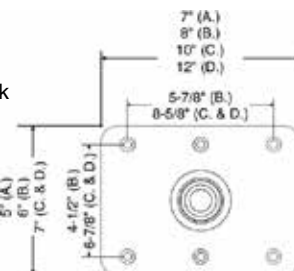

7" x 7" NON-LOCKING SQUARE BASE

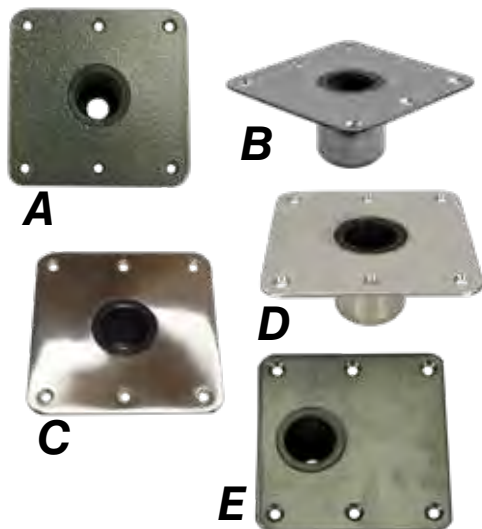

RETAIL IMAGE	PART NUMBER	DESCRIPTION	MATERIAL	FINISH	PACK QUANTITY	ABYC
A	1640007-CL	7" x 7" BASE	MILD STEEL	BLACK KRINKLE	6 RETAIL	B
C	1640013-CL	7" x 7" BASE	STAINLESS STEEL	SATIN	6 RETAIL	B

Retail packed in clamshell with 4-color label

OEM IMAGE	PART NUMBER	DESCRIPTION	MATERIAL	FINISH	PACK QUANTITY	ABYC
A	3640007-CL	7" x 7" BASE	MILD STEEL	BLACK KRINKLE	20 BULK	B
B	3640012-PASSCL	7" x 7" BASE	STAINLESS STEEL	POLISHED	20 BULK	B
C	3640013-CL	7" x 7" BASE	STAINLESS STEEL	SATIN	20 BULK	B
D	3640012-CL	7" x 7" UNDER CARPET	STAINLESS STEEL	MILL	20 BULK	B
E	3640021-CL	7" x 7" OFFSET BASE	MILD STEEL	BLACK KRINKLE	20 BULK	B

7" x 7" square base is available in stainless or mild steel finishes and varying applications.

- Below deck mount requires a 4" hole in deck
- Use with any Spring-Lock™ or Clip-Lock post

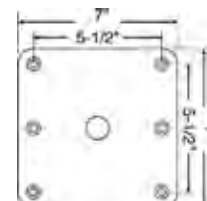

SPRING-LOCK™ SERIES

7" x 7" LOCKING SQUARE BASE

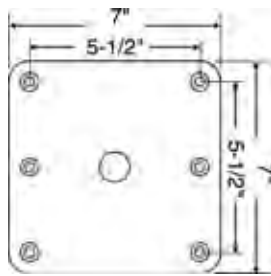

OEM IMAGE	PART NUMBER	DESCRIPTION	MATERIAL	FINISH	PACK QUANTITY	ABYC
A	3680012-PASSCL	7" x 7" BASE	STAINLESS STEEL	POLISHED	20 BULK	AD
B	3680013-CL	7" x 7" BASE	STAINLESS STEEL	SATIN	20 BULK	AD
C	3680038-CL	4" x 8" BASE	STAINLESS STEEL	SATIN	20 BULK	AD

Bases are stainless steel construction.

- Below deck requires a 4" hole in deck
- Use with any locking Spring-Lock™ post (sold separately)
- Rotational stop installed in base to comply with ABYC AD rating



A Polished



B Satin



C Satin

SPRING-LOCK™ SERIES

SPRING-LOCK™ & CLIP-LOCK ACCESSORIES



A Seat Mount Bushing



B Locking Latch

RETAIL IMAGE	PART NUMBER	DESCRIPTION	PACK QUANTITY
A	2100010	REPLACEMENT SEAT MOUNT BUSHING	6 RETAIL
B	2100011	REPLACEMENT LOCKING LATCH	6 RETAIL
C	2100012	REPLACEMENT END CAP	6 RETAIL
D	2100013	REPLACEMENT POST BUSHING	6 RETAIL
E	2100038	SPRING-LOCK™ BASE REPAIR KIT - 2 BUSHINGS	6 RETAIL
F	2100040	SPRING-LOCK™ II BASE REPAIR KIT	6 RETAIL
G	2100091	BASE SOCKET COVER (SOLD IN PAIRS)	6 RETAIL

Retail packed in box or polybag

OEM IMAGE	PART NUMBER	DESCRIPTION	PACK QUANTITY
G	2100091-B	BASE SOCKET COVER	20 BULK
H	3640023	SPLASH GUARD	20 BULK
I	3640420	SPRING-LOCK™ 18.5" EXTENSION	20 BULK

Base repair kits (E and F) include: 1/2 oz bottle of glue with brush cap, plastic bushing, and wooden dowel mandrel.



C End Cap



D Post Bushing



G 3/4" Deck Base Socket Cover (sold as pairs)

I 18.5" Extension to add height to existing post



E Base Repair Kit (for models pre 2010)
Used on Spring-Lock™ base sockets under 2"



F Base Repair Kit (for models 2010 and newer)
Used on current Spring-Lock™ II base sockets 2"



H Installed on base below deck to prevent water from entering into compartments below



- SEAT MOUNTS
- SLIDES
- SWIVELS
- PEDESTALS
- PACKAGES

2-3/8" Series

SPRINGFIELD Marine's first-generation non-removable pedestal system, the 2-3/8" series, remains highly popular for inland boats. This system features a die-cast base and a 2-3/8" aluminum extruded post, complemented by our renowned Trac-Lock™ slides and swivels. The Trac-Lock™ components, made from aluminum die-cast, powder-coated swivel, and extruded slide plates, ensure a secure connection between the post and seat pedestal.

This series exceeds the ABYC H-31 requirements for strength and durability. It has been rigorously tested both in the lab and in the field, boasting a proven track record of reliability and safety.

REQUIRES 3 LOCKING SLITS 90° APART.
ONE LOCKING SLIT MUST BE ON THE
SAME SIDE AS A MOUNTING HOLE.

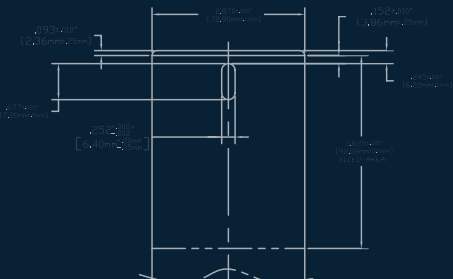
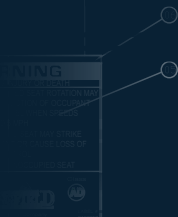
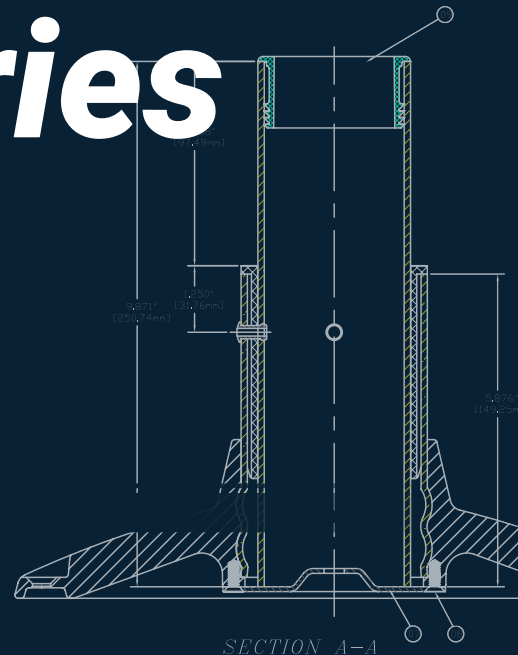

2-3/8" SERIES

REGULAR MAINSTAY PACKAGE



A Non-locking Swivel

C Locking Slide & Swivel

B Locking Swivel

RETAIL IMAGE	PART NUMBER	ADJUSTS	SEAT MOUNT	PACK QUANTITY	ABYC
B	1250100-L1	14" to 20"	3100031-LAR1	1 RETAIL	AD
C	1250150-L1	14.5" to 20.5"	3100531-LAR1	1 RETAIL	AD

Retail packed in box with 4-color label

OEM IMAGE	PART NUMBER	ADJUSTS	SEAT MOUNT	PACK QUANTITY	ABYC
A	1250100	14" to 20"	3100031-AR1	1 BULK	AP
B	1250100-L	14" to 20"	3100031-LAR1	1 BULK	AD
C	1250150-L	14.5" to 20.5"	3100531-LAR1	1 BULK	AD

Available in locking or non-locking Trac-Lock™ swivel or slide & swivel. 2-3/8" pedestal with 9" round anodized base.

- Air-powered height adjustment
- 500 Newton cylinder

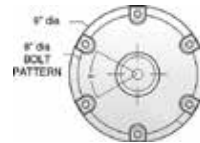

SHORT MAINSTAY PACKAGE



A Locking Swivel

B Locking Slide & Swivel

RETAIL IMAGE	PART NUMBER	ADJUSTS	SEAT MOUNT	PACK QUANTITY	ABYC
A	1250200-L1	12" to 15.5"	3100031-LAR1	1 RETAIL	AD
B	1250250-L1	12.5" to 16"	3100531-LAR1	1 RETAIL	AD

Retail packed in box with 4-color label

OEM IMAGE	PART NUMBER	ADJUSTS	SEAT MOUNT	PACK QUANTITY	ABYC
A	1250200-L	12" to 15.5"	3100031-LAR1	1 BULK	AD
A	1250206-L	10" to 12"	3100031-LAR1	1 BULK	AD
B	1250250-L	12.5" to 16"	3100531-LAR1	1 BULK	AD
B	1250256-L	10.5" to 12.5"	3100531-LAR1	1 BULK	AD

Available in locking Trac-Lock™ swivel or slide & swivel. 2-3/8" pedestal with 9" round anodized base.

- Air-powered height adjustment from 10" to 16"
- Extra locking slot positioned at 45° (#1250256-LN)
- 500 Newton cylinder

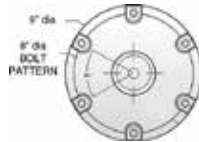

THRU-DECK MAINSTAY



A Slide & Swivel

B Swivel Only

OEM IMAGE	PART NUMBER	ADJUSTS	SEAT MOUNT	PACK QUANTITY	ABYC
A	1250252-L	9" to 12"	3100531-LAR1	1 BULK	AD
A	1250253-L	8-3/4" to 14-1/2"	3100531-LAR1	1 BULK	AD
B	1250254-L	8-1/4" to 14"	3100031-LAR1	1 BULK	AD

Retail packed in box with 4-color label

Available in locking Trac-Lock™ swivel or slide & swivel. 2-3/8" pedestal with 9" round anodized base.

- Air-powered height adjustment
- Thru-deck pedestals require a 3-3/4" hole in deck
- 500 Newton cylinder



EXPLORER ADJUSTABLE PACKAGE



A Slide & Swivel

B Swivel Only

C Pedestal Only

RETAIL IMAGE	PART NUMBER	ADJUSTS	SEAT MOUNT	PACK QUANTITY	ABYC
B	1253032-L1	13-5/8" to 16-5/8"	3100031-L1	1 RETAIL	AD

Retail packed in box with 4-color label

OEM IMAGE	PART NUMBER	ADJUSTS	SEAT MOUNT	PACK QUANTITY	ABYC
A	1253031-L	13-7/8" to 16-7/8"	3100531-L1	1 BULK	AD
B	1253032-L	13-5/8" to 16-5/8"	3100031-L1	1 BULK	AD
C	1253031-MNS	12-1/2" to 15-1/2"	NOT INCLUDED	5 BULK	AD
C	1253035-MNS	10-1/2" to 13-1/2"	NOT INCLUDED	5 BULK	AD

Available with locking Trac-Lock™ swivel or slide & swivel. 2-3/8" adjustable pedestal with 9" round satin finish base.

- Pedestal adjusts in 1-inch increments
- Anodized post
- Proprietary posi-lock system



EXPLORER FIXED-HEIGHT PACKAGE



A Non-Locking Swivel

B Locking Swivel

RETAIL IMAGE	PART NUMBER	FIXED HEIGHT	SEAT MOUNT	PACK QUANTITY	ABYC
A	1250309	9"	3100031-1	1 RETAIL	AP
B	1250309-L	9"	3100031-L1	1 RETAIL	AD
A	1250312	12"	3100031-1	1 RETAIL	AP
B	1250312-L	12"	3100031-L1	1 RETAIL	AD
B	1250313-L	13"	3100031-L1	1 RETAIL	AD
A	1250315	15"	3100031-1	1 RETAIL	AP
B	1250315-L	15"	3100031-L1	1 RETAIL	AD

Retail packed in box with 4-color label

Anodized fixed height post with die cast satin base. Available with locking or non-locking Trac-Lock™ swivel or slide & swivel.

- 2-3/8" pedestal with 9" round base



EXPLORER FIXED-HEIGHT PEDESTAL



A Locking Satin



RETAIL IMAGE	PART NUMBER	HEIGHT	LOCK / NON-LOCK	PACK QUANTITY	ABYC
A	1250309-LNS	9"	LOCKING	1 RETAIL	AD
A	1250310-LNS	10"	LOCKING	1 RETAIL	AD
A	1250312-LNS	12"	LOCKING	1 RETAIL	AD
A	1250313-LNS	13"	LOCKING	1 RETAIL	AD
A	1250314-LNS	14"	LOCKING	1 RETAIL	AD
A	1250315-LNS	15"	LOCKING	1 RETAIL	AD

Retail packed in box with label

OEM IMAGE	PART NUMBER	HEIGHT	LOCK / NON-LOCK	PACK QUANTITY	ABYC
A	1250308-MLNS	8"	LOCKING	5 BULK	AD
A	1250309-MLNS	9"	LOCKING	5 BULK	AD
A	1250310-MLNS	10"	LOCKING	5 BULK	AD
A	1250351-MLNS	11"	LOCKING	5 BULK	AD
A	1250312-MLNS	12"	LOCKING	5 BULK	AD
A	1250313-MLNS	13"	LOCKING	5 BULK	AD
A	1250354-MLNS	14"	LOCKING	5 BULK	AD
A	1250315-MLNS	15"	LOCKING	5 BULK	AD

Anodized aluminum 2-3/8" pedestal with 9" round satin base.

- Use with Trac-Lock™ slide or swivel (sold separately)
- Available in a variety of heights

2-3/8" SERIES

CLIPPER ADJUSTABLE PACKAGE

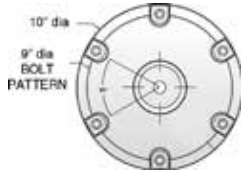

RETAIL IMAGE	PART NUMBER	ADJUSTS	SEAT MOUNT	PACK QUANTITY	ABYC
A	1440334	13" to 18"	3100031-1	1 RETAIL	B

Retail packed in box with 4-color label

Anodized finish, 2-3/8" adjustable pedestal with 10" round base.

- Adjusts 13" to 18" in 1-inch increments
- Includes non-locking Trac-Lock™ swivel



CLIPPER FIXED-HEIGHT PACKAGE

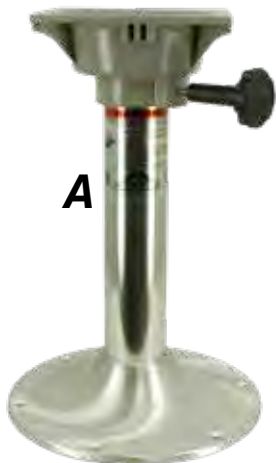

Non-Locking



Locking

RETAIL IMAGE	PART NUMBER	ADJUSTS	SEAT MOUNT	PACK QUANTITY	ABYC
A	1440213	9"	3100031-1	1 RETAIL	AP
B	1440213-L	9"	3100031-L1	1 RETAIL	AD
A	1440220	12"	3100031-1	1 RETAIL	AP
B	1440220-L	12"	3100031-L1	1 RETAIL	AD
A	1440228	15"	3100031-1	1 RETAIL	AP

Retail packed in box with label

Anodized fixed height 2-3/8" pedestal with 10" round satin base.

- Available with locking or non-locking Trac-Lock™ swivel

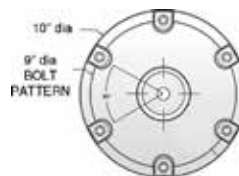

2-3/8" SERIES

CLIPPER FIXED-HEIGHT PEDESTAL

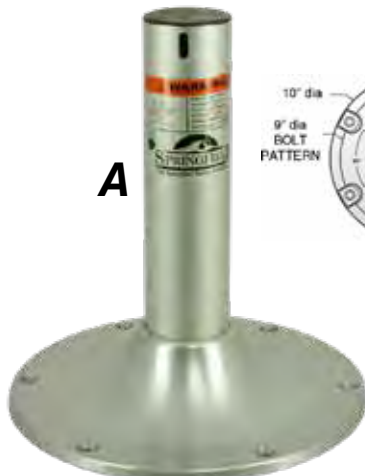

Anodized Post & Base

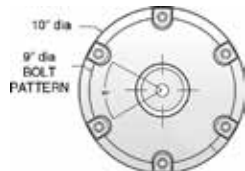

RETAIL IMAGE	PART NUMBER	HEIGHT	POST FINISH	PACK QUANTITY	ABYC
A	1440013-SAL	13"	ANODIZED	1 RETAIL	AD

Retail packed in box with label

OEM IMAGE	PART NUMBER	HEIGHT	POST FINISH	PACK QUANTITY	ABYC
A	1440607-MAL	7"	ANODIZED	5 BULK	AD
A	1440609-MAL	9"	ANODIZED	5 BULK	AD
A	1440610-MAL	10"	ANODIZED	5 BULK	AD
A	1440612-MAL	12"	ANODIZED	5 BULK	AD
A	1440613-MAL	13"	ANODIZED	5 BULK	AD
A	1440615-MAL	15"	ANODIZED	5 BULK	AD

2-3/8" pedestal with 10" round base and 9" mounting pattern.

- Use with locking Trac-Lock™ slide or swivel (sold separately)
- Available in a variety of heights



TRAC-LOCK™ SWIVEL



A Non-Locking



B Locking



C Non-Locking Air-Ride

RETAIL IMAGE	PART NUMBER	DESCRIPTION	PACK QUANTITY	ABYC
A	1100031-1	NON-LOCKING SWIVEL	6 RETAIL	AP
B	1100031-L1	LOCKING SWIVEL	6 RETAIL	AD

Retail packed in clamshell with 4-color label

OEM IMAGE	PART NUMBER	DESCRIPTION	PACK QUANTITY	ABYC
A	3100031-1	NON-LOCKING SWIVEL	20 BULK	AP
B	3100031-L1	LOCKING SWIVEL	20 BULK	AD
C	3100031-LAR1	LOCKING AIR-RIDE SWIVEL	20 BULK	AD

Made of high-strength aluminum with powder-coat finish. 2-3/8" post mount with bushing for snug fit. Centrally located locking handle that is easily reachable with left or right hand.

- Available as air-ride, locking, or non-locking
- Swivel rotates 360°
- Adds 7/8" to height of pedestal

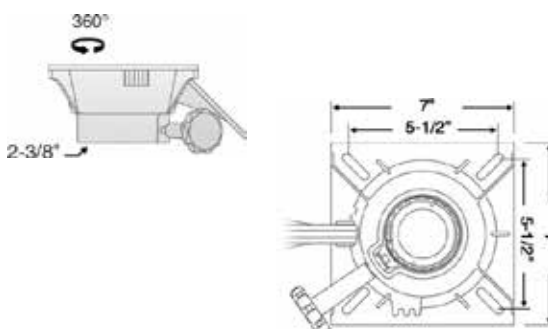

TRAC-LOCK™ SLIDE & SWIVEL



A Non-Locking



B Locking



C Locking Air-Ride

RETAIL IMAGE	PART NUMBER	DESCRIPTION	PACK QUANTITY	ABYC
A	1100531-1	NON-LOCKING SLIDE & SWIVEL	6 RETAIL	AP
B	1100531-L1	LOCKING SLIDE & SWIVEL	6 RETAIL	AD

Retail packed in clamshell with 4-color label

OEM IMAGE	PART NUMBER	DESCRIPTION	PACK QUANTITY	ABYC
A	3100531-1	NON-LOCKING SLIDE & SWIVEL	10 BULK	AP
B	3100531-L1	LOCKING SLIDE & SWIVEL	10 BULK	AD
C	3100531-LAR1	LOCKING AIR-RIDE SLIDE & SWIVEL	10 BULK	AD

Large 7-1/4" x 13" seat mounting platform travels 5-1/4" forward and backward on self-lubricating pads. Centrally located locking handle that is easily reachable with left or right hand.

- Adds 1-1/4" to height of pedestal
- High-strength aluminum
- Swivel rotates 360°

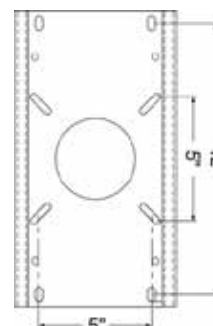
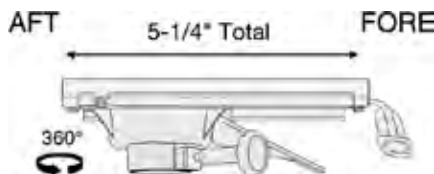

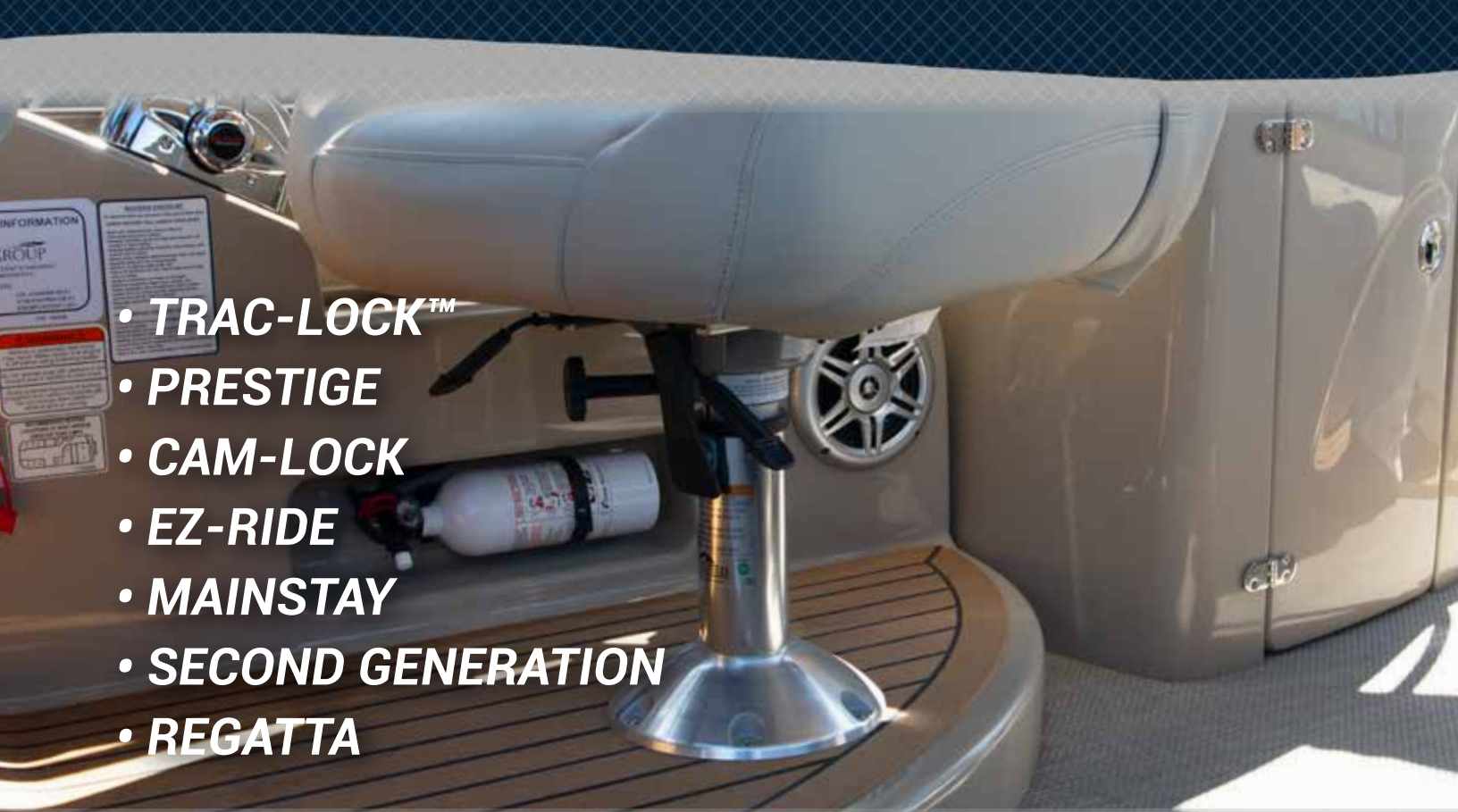

- **TRAC-LOCK™**
- **PRESTIGE**
- **CAM-LOCK**
- **EZ-RIDE**
- **MAINSTAY**
- **SECOND GENERATION**
- **REGATTA**

2-7/8" Series

SPRINGFIELD Marine's second-generation non-removable pedestal system in the 2-7/8" series is designed for today's larger and faster recreational boats. This system features a heavy-duty base and post, crafted for maximum strength and durability. The base is made from permanent mold AC7A aluminum alloy with an anodized finish, providing superior strength and corrosion protection.

The 2-7/8" heavy-duty extruded post is pressed and hydra-formed into the base, mechanically forming a robust and sturdy pedestal. This proprietary process ensures maximum strength and a secure, reliable connection between the post and the base.

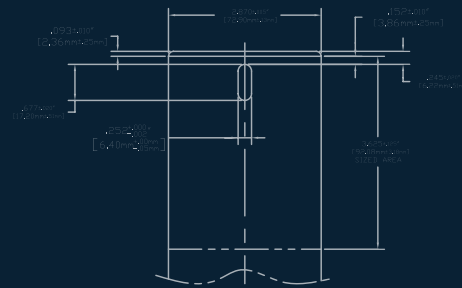
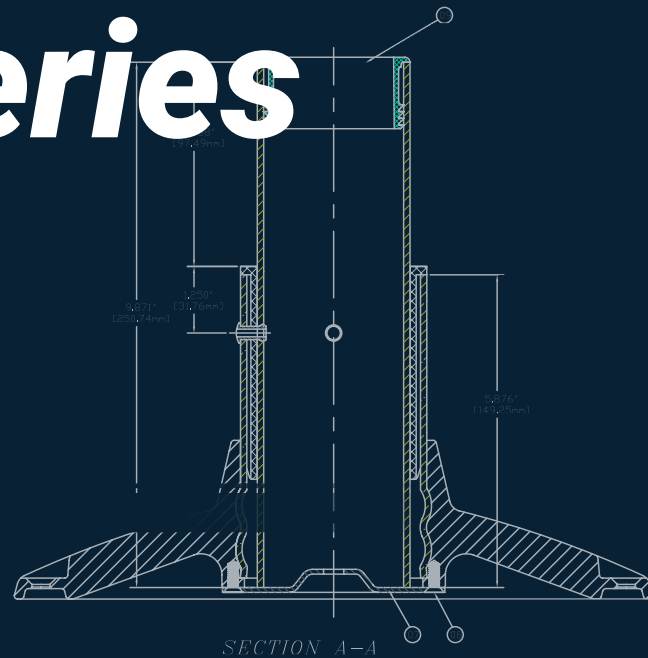

HEAVY-DUTY MAINSTAY PACKAGE



OEM IMAGE	PART NUMBER	ADJUSTS	SEAT MOUNT	BASE SIZE	PACK QUANTITY	ABYC
A	1250300	14" to 19-1/2"	3100021-LAR1	9"	1 BULK	AD
B	1250301	14-1/2" to 20"	3100521-LAR1	9"	1 BULK	AD
B	1250450-L	12" to 14-3/4"	3100521-LAR1	9"	1 BULK	AD
B	1250456-L	10" to 12"	3100521-LAR1	9"	1 BULK	AD
C	1250456-LC	10" to 12"	3100521-LAR1	9"	1 BULK	AD
D	1250456-LCNS	8.5" to 12"	N/A	9"	1 BULK	AD

- 2-7/8" pedestal with 9" round anodized base
- Rigid 4-keyed aluminum post, anodized finish
 - Air-powered height adjustment
 - 3-1/2" out post with 2-7/8" inner post
 - 500 Newton cylinder



12" HEAVY-DUTY MAINSTAY PEDESTAL



OEM IMAGE	PART NUMBER	ADJUSTS	BASE SIZE	SEAT MOUNT	PACK QUANTITY	ABYC
A	1250321	14-1/2" to 20"	12"	3100521-LAR	1 BULK	AD
B	1250321-NS	13-1/4" to 18-3/4"	12"	NO SWIVEL	1 BULK	AD
B	1250326-NS	16-1/2" to 23"	12"	NO SWIVEL	1 BULK	AD
B	1250328-NS	24" to 30-1/2"	12"	NO SWIVEL	1 BULK	AD
D	1252140	25-1/4" to 32-3/4"	12"	3101521-LARW	1 BULK	AD

- 2-7/8" pedestal with 12" round base, anodized finish.
- Rigid 4-keyed aluminum post
 - Air-powered height adjustment
 - 3-1/2" out post with 2-7/8" inner post

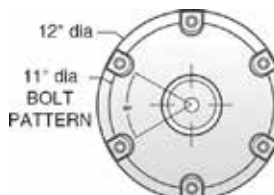

2ND GENERATION ADJUSTABLE PEDESTAL



RETAIL IMAGE	PART NUMBER	ADJUSTS	FINISH	PACK QUANTITY	ABYC
A	1240751-L1	14" to 20"	ANODIZED	1 RETAIL	AD
B	1240749-LNS	15" to 21.5"	ANODIZED	1 RETAIL	AD

Retail packed in box with 4-color label

OEM IMAGE	PART NUMBER	ADJUSTS	FINISH	PACK QUANTITY	ABYC
B	1240748-MLNS	12" to 14-3/4"	ANODIZED	5 BULK	AD
B	1240749-MLNS	14" to 20"	ANODIZED	5 BULK	AD
B	1240752-MLNS	15.25" to 21.25"	ANODIZED	5 BULK	AD
B	1240751-MLNS	18" to 24"	ANODIZED	5 BULK	AD
B	1240750-MLNS	20" to 26"	ANODIZED	5 BULK	AD

- 2-3/8" inner post with 2-7/8" locking adapter and 9" round base. Anodized post and base.
- Adjusts in 1" increments
 - Use with 2-7/8" Trac-Lock™ slide or swivel (sold separately)
 - Proprietary posi-lock system



2-7/8" SERIES

THRU-DECK ELECTRIC PEDESTAL

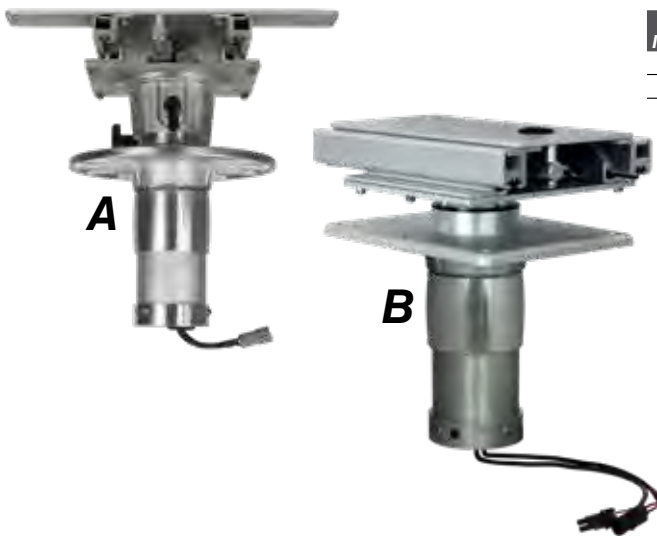

OEM IMAGE	PART NUMBER	ADJUSTS	FINISH	PACK QUANTITY	ABYC
A	1271380-02	7-1/4" to 11-1/4"	ALUMINUM	1 BULK	AD
B	1271385-01	5" to 9"	ALUMINUM	1 BULK	AD
-	1271385-BLK	5" to 9"	BLACK ANODIZED	1 BULK	AD

Heavy-duty electric actuated thru-deck pedestal with anodized cast aluminum base.

- Requires 12V DC / 14 AMP power
- Black anodized finish available, special order
- Electric actuated seat slide
- Electric actuated height adjustment
- Lift force of 450 lbs
- Meets ABYC H-31 drop and pull tests



ELECTRIC MAINSTAY

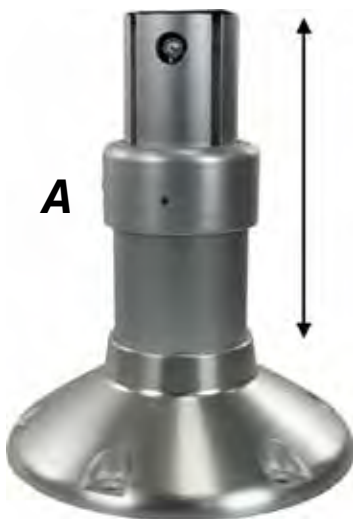

OEM IMAGE	PART NUMBER	ADJUSTS	BASE SIZE	PACK QUANTITY	ABYC
A	1251415-02	12-1/8" to 14-1/8"	9"	1 BULK	AD
A	1251415-04	14-1/8" to 18-1/8"	9"	1 BULK	AD
A	1251315-06	16-1/8" to 22-1/8"	12"	1 BULK	AD
A	1251415-04L	14-1/8" to 18-1/8"	12"	1 BULK	AD

Heavy-duty electric mainstay with 12V in-line actuator

- Requires 12V DC / 14 AMP power
- 9" or 12" base available
- Use with electric slide (sold separately)

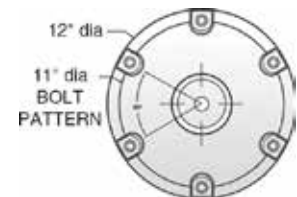
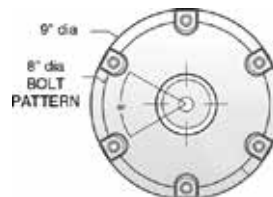

2-7/8" SERIES

ELECTRIC TRAC-LOCK™



OEM IMAGE	PART NUMBER	DESCRIPTION	PACK QUANTITY	ABYC
A	3100521-EL1	TRAC-LOCK™ ELECTRIC SLIDE & SWIVEL	1 BULK	AD
B	3101521-LE	PRESTIGE ELECTRIC SLIDE & SWIVEL	1 BULK	AD

High-strength aluminum slide & swivel rotates 360°. Large 7-1/4" x 13" seat mounting platform travels 5-14" forward and backward on self-lubricating pads. Centrally located locking handle is easily reachable with left or right hand.

- Adds 1-1/4" to height of pedestal
- Requires 12V DC / 14 AMP power

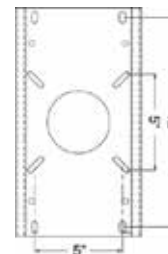

2ND GENERATION PACKAGE



RETAIL IMAGE	PART NUMBER	HEIGHT	SEAT MOUNT	PACK QUANTITY	ABYC
B	1240609-L1	9"	3100021-L1	1 RETAIL	AD
B	1240612-L1	12"	3100021-L1	1 RETAIL	AD
A	1240616	12"	3100021-1	1 RETAIL	AP
C	1240716-L	12"	3100521-L1	1 RETAIL	AD
B	1240615-L1	15"	3100021-L1	1 RETAIL	AD
A	1240629	18"	3100021-1	1 RETAIL	AP
B	1240629-L	18"	3100021-L1	1 RETAIL	AD
C	1240729-L	18"	3100521-L1	1 RETAIL	AD
A	1240639	24"	3100021-1	1 RETAIL	AP
B	1240639-L	24"	3100021-L1	1 RETAIL	AD
C	1240739-L	24"	3100521-L1	1 RETAIL	AD
B	1240646-L	30"	3100021-L1	1 RETAIL	AD

Retail packed in box with 4-color label

Available in a variety of heights with locking or non-locking Trac-Lock™ slide & swivel.

- 2-7/8" Pedestal with 9" round anodized base
- 2-7/8" High-strength anodized aluminum post



TRAC-LOCK™ SWIVEL



RETAIL IMAGE	PART NUMBER	DESCRIPTION	PACK QUANTITY	ABYC
A	1100021-1	NON-LOCKING SWIVEL	6 RETAIL	AP
B	1100021-L1	LOCKING SWIVEL	6 RETAIL	AD

Retail packed in clamshell with 4-color label

OEM IMAGE	PART NUMBER	DESCRIPTION	PACK QUANTITY	ABYC
A	3100021-1	NON-LOCKING SWIVEL	20 BULK	AP
B	3100021-L1	LOCKING SWIVEL	20 BULK	AD
C	3100021-CR1	NON-LOCKING CHROME SWIVEL	20 BULK	AP
D	3100021-LAR1	LOCKING AIR-RIDE SWIVEL	20 BULK	AD

2-7/8" post mount with bushing & tension knob for snug fit. Made of high-strength aluminum with powder coat finish.

- Rotates 360°
- Available as air-ride locking or non-locking
- Centrally located locking handle, easily reachable with left or right hand
- Adds 7/8" to height of pedestal

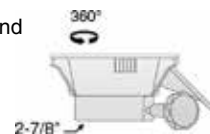

TRAC-LOCK™ SLIDE / SWIVEL

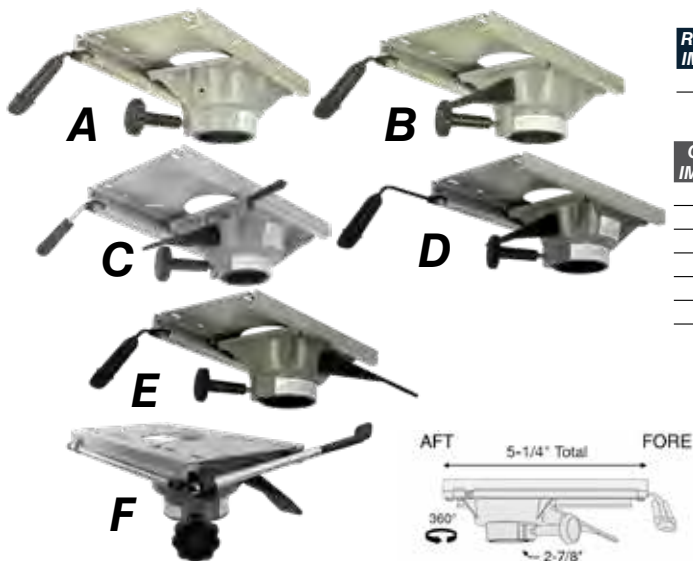

RETAIL IMAGE	PART NUMBER	DESCRIPTION	PACK QUANTITY	ABYC
A	1100521-1	NON-LOCKING SLIDE & SWIVEL	6 RETAIL	AP
B	1100521-L1	LOCKING SLIDE & SWIVEL	6 RETAIL	AD

Retail packed in box with 4-color label

OEM IMAGE	PART NUMBER	DESCRIPTION	PACK QUANTITY	ABYC
A	3100521-1	NON-LOCKING SLIDE & SWIVEL	10 BULK	AP
B	3100521-L1	LOCKING SLIDE & SWIVEL	10 BULK	AD
C	3100521-LAR1	LOCKING AIR-RIDE SLIDE & SWIVEL	10 BULK	AD
D	3100521-LE1	LOCKING EXTENDED SLIDE HANDLE	10 BULK	AD
E	3100521-LL1	LEFT LOCKING SWIVEL HANDLE	10 BULK	AD
F	3100521-LLL1	LEFT LOCKING CONTROLS	10 BULK	AD
-	3100521-LS1	SHORT HANDLE SLIDE	10 BULK	AD

High-strength aluminum, available as air-ride, locking, or non-locking slides and swivels. Large 7-1/4" x 13" seat mounting platform travels 5-1/4" forward and backward on self-lubrication pads. Centrally located locking handle that is easily reachable with left or right hand.

- Adds 1-1/4" of height to pedestal
- Rotates 360°



2-7/8" SERIES

COMPOSITE TRAC-LOCK™

OEM IMAGE	PART NUMBER	DESCRIPTION	PACK QUANTITY	ABYC
A	3100525	COMPOSITE TRAC-LOCK™ SLIDE & SWIVEL NON-LOCKING	1 BULK	AP
B	3100525-L	COMPOSITE TRAC-LOCK™ SLIDE & SWIVEL LOCKING	1 BULK	AD



Heavy-duty robust composite Trac-Lock™ slide & swivel.

- Modular handles for driver or passenger locations
- Cast aluminum ergonomic handles for comfort and ease of operation
- Cam-action tension handle limits unwanted movement
- 5-1/4" of travel fore and aft, 360° of rotation



2-7/8" CAM-LOCK SLIDE & SWIVEL

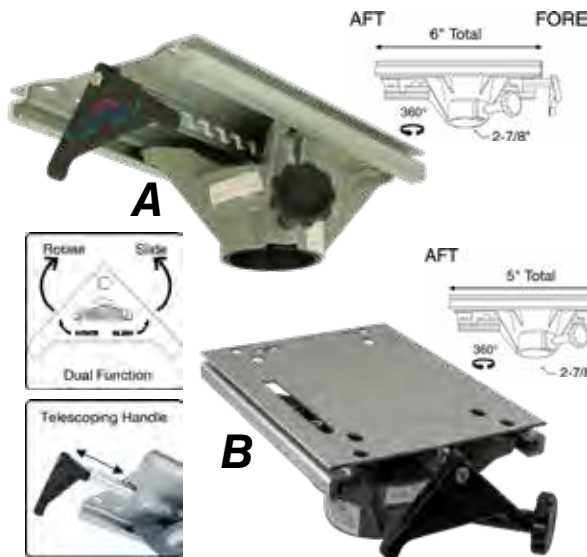

RETAIL IMAGE	PART NUMBER	DESCRIPTION	PACK QUANTITY	ABYC
A	1100930-A1	SLIDE & SWIVEL W/TELESCOPING HANDLE	1 RETAIL	AD

Retail packed in clamshell with 4-color label

OEM IMAGE	PART NUMBER	DESCRIPTION	PACK QUANTITY	ABYC
A	3100930-A1	SLIDE & SWIVEL W/TELESCOPING HANDLE	10 BULK	AD
B	3100930-A1N	5" CAM-LOCK LIMITED ROTATION	10 BULK	AD
B	3100931*	5" SHORT CAM-LOCK	10 BULK	AD

High-strength aluminum platform travels 6" forward and backward on self-lubricating pads. Automatically locks in forward position. Dual function activator handle operates slide as well as swivel, rotates 360°.

- Handle telescopes up to add 1-1/2" to height of pedestal
- Patent: #5,704,729

PLATFORM

- A: 7-1/4" x 13"
- B: 7-1/4" x 9-1/2"

MOUNTING PATTERN

- A: Universal 5" x 5" and 5" x 12"
- B: Non-Standard 5" x 9-1/2"



* 3100931 is used for bolster seats with 7-1/4" x 9-1/2" platform, 5" x 9-1/2" mounting pattern

PRESTIGE SLIDES

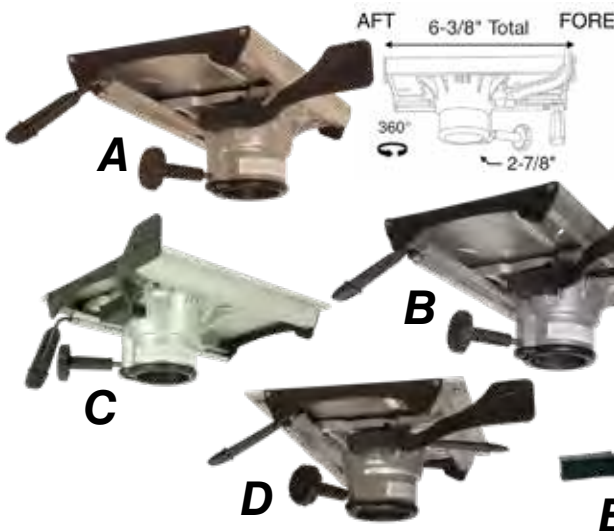

OEM IMAGE	PART NUMBER	DESCRIPTION	PACK QUANTITY	ABYC
A	3101521-L	LOCKING SLIDE & SWIVEL	10 BULK	AD
B	3101521-LAR	AIR-RIDE SLIDE & SWIVEL	8 BULK	AD
C	3101521-LW	SLIDE & SWIVEL, EXTRA WIDE PLATE	8 BULK	AD
D	3101521-LARW	AIR-RIDE SLIDE & SWIVEL, EXTRA WIDE PLATE	8 BULK	AD
E	5191131	REPLACEMENT LOCK HANDLE	10 BULK	AD

2-7/8" locking Prestige slides & swivels built with a heavy-duty aluminum cast swivel, deep throat and extended bushing for our most secure seat mount. Large 8" x 13" seat mount platform (extra wide: 14" x 13") travels 6-3/8" forward and backwards with easy-to-reach extra-large ergonomic fit under seat handles.

- Adds 1-1/4" to height of pedestal
- Plastic end caps for aesthetic design under seat
- Smooth anodized slide plate for function and design

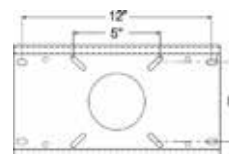

2-7/8" SERIES

2ND GENERATION FIXED-HEIGHT PEDESTAL



OEM IMAGE	PART NUMBER	HEIGHT	PACK QUANTITY	ABYC
A	1240008-SAL	8"	1 BULK	AD
A	1240012-SAL	12"	1 BULK	AD
A	1240015-SAL	15"	1 BULK	AD
A	1240030-SAL	30"	1 BULK	AD

OEM IMAGE	PART NUMBER	HEIGHT	PACK QUANTITY	ABYC
A	1240006-DAL	6"	2 BULK	AD
A	1240007-DAL	7"	2 BULK	AD
A	1240009-DAL	9"	2 BULK	AD
A	1240012-DAL	12"	2 BULK	AD
A	1240014-DAL	14"	2 BULK	AD
A	1240018-DAL	18"	2 BULK	AD
A	1240020-DAL	20"	2 BULK	AD
A	1240024-DAL	24"	2 BULK	AD

OEM IMAGE	PART NUMBER	HEIGHT	PACK QUANTITY	ABYC
A	1240006-MAL	6"	5 BULK	AD
A	1240007-MAL	7"	5 BULK	AD
A	1240008-MAL	8"	5 BULK	AD
A	1240009-MAL	9"	5 BULK	AD
A	1240010-MAL	10"	5 BULK	AD
A	1240011-MAL	11"	5 BULK	AD
A	1240012-MAL	12"	5 BULK	AD

Permanent mold base is made form high magnesium aluminum for corrosion resistance. Hydro-formed for optimal rotational torque and welded for safety assurance.

- Use with locking Trac-Lock™ slide or swivel (sold separately)
- Additional sizes and non-locking pedestals available upon request



STAINLESS STEEL FIXED-HEIGHT

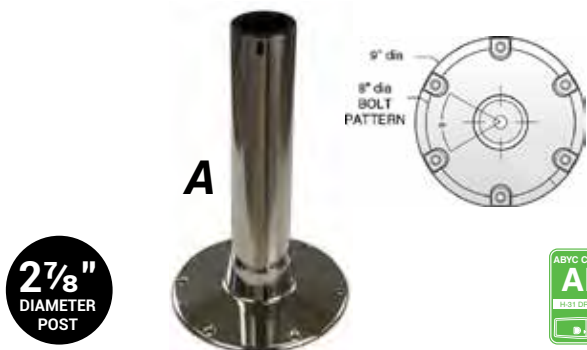

OEM IMAGE	PART NUMBER	FIXED	BASE SIZE	PACK QUANTITY	ABYC
A	1280606-SS	6"	9"	2 BULK	AD
A	1280608-SS	8"	9"	2 BULK	AD
A	1280610-SS	10"	9"	2 BULK	AD
A	1280618-SS	18"	9"	2 BULK	AD
A	1280624-SS	24"	9"	2 BULK	AD

Polished cast 9" round stainless steel base, welded to post for maximum strength. 2-7/8" post with heavy-duty thick wall construction. 316 grade stainless steel with #8 mirror finish.

- Use with any 2-7/8" Trac-Lock™ locking slide or swivel (sold separately)
- Available in a variety of heights upon request



TRAC-LOCK™ LIMITED ROTATION



OEM IMAGE	PART NUMBER	DESCRIPTION	PACK QUANTITY	ABYC
-	3100023-L	TRAC-LOCK™ LIMITED ROTATION SWIVEL	20 BULK	AD
-	3100253-LAR	TRAC-LOCK™ LIMITED ROTATION SWIVEL & SLIDE W/AIR-RIDE HANDLE	10 BULK	AD
-	3100523-LAR	TRAC-LOCK™ LIMITED ROTATION SWIVEL & SLIDE	10 BULK	AD

Restriction piece designed to limit rotation range. High-strength aluminum with powder-coat for lasting corrosion resistance. Requires two (2) stop bolts on pedestal.



HEAVY-DUTY 2ND GENERATION PEDESTAL



OEM IMAGE	PART NUMBER	FIXED HEIGHT	BASE SIZE	FINISH	PACK QUANTITY	ABYC
A	1270710-1DALW	10"	12"	ANODIZED	2 BULK	AD

Permanent mold 12" base made of high-magnesium aluminum alloy for strength and corrosion resistance.

- Anodized 2-7/8" post with anodized cast aluminum base



2-7/8" SERIES

TRAC-LOCK™ CABLE-ACTIVATED SLIDE

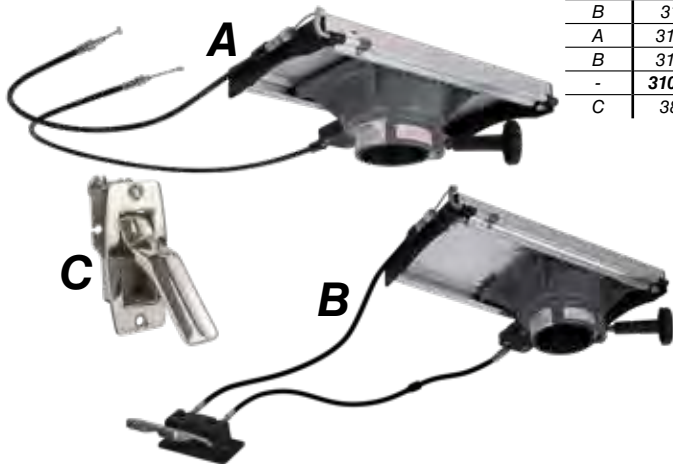

OEM IMAGE	PART NUMBER	DESCRIPTION	PACK QUANTITY	ABYC
B	3100521-CL1	CABLE-ACTIVATED SLIDE W/CONTROLS	6 BULK	AD
A	3100521-CL02	CABLE-ACTIVATED SLIDE, NO CNTRL	6 BULK	AD
B	3100521-CL03	CABLE-ACTIVATED SLIDE, SINGLE CONTROL	6 BULK	AD
-	3100521-CL04N	CABLE-ACTIVATED SLIDE, NO CNTRL, WIAR HANDLE	10 BULK	AD
C	3840045-SS*	CABLE PULL ACTIVATOR HANDLE	20 BULK	AD

Cable-activated slide with 5-1/4" total fore and aft travel range. High-strength aluminum anodized 7/16" x 13" platform added 1-1/4" of height to pedestal.

- Rotates 360°
- Use with 2-7/8" series locking fixed height posts / pedestals (sold separately)

* **3840045-SS**: Recommended for use with Trac-Lock™ Cable-activated Slide (#3100521-CL02). Constructed of stainless steel with a polish finish for a luxurious look. Designed to activate fore & aft slide movement with a simple pull of the lever.



BLACK ANODIZED PEDESTAL, SLIDE / SWIVEL

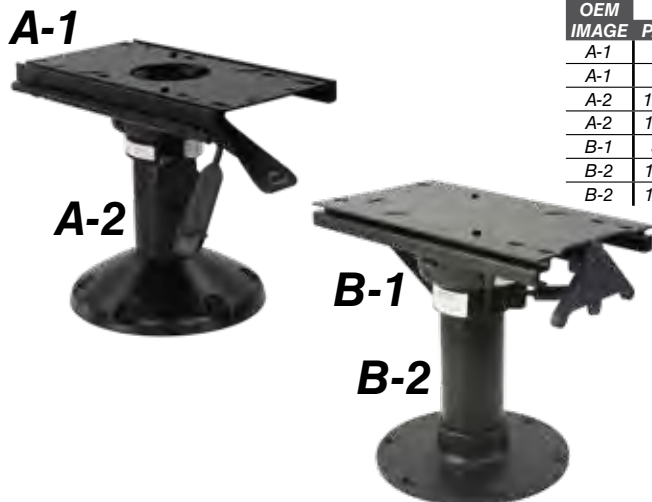

OEM IMAGE	PART NUMBER	DESCRIPTION	PACK QUANTITY	ABYC
A-1	3100521-L1B	TRAC-LOCK™ SLIDE & SWIVEL, LOCKING	10 BULK	AD
A-1	3100521-1B	TRAC-LOCK™ SLIDE & SWIVEL, NON-LOCKING	10 BULK	AP
A-2	1240009-MALB	2ND GENERATION 9" PEDESTAL	5 BULK	AD
A-2	1240012-MALB	2ND GENERATION 12" PEDESTAL	5 BULK	AD
B-1	3100930-A1B	CAM-LOCK SLIDE & SWIVEL	10 BULK	AD
B-2	1280104-MALB	2-7/8" REGATTA PEDESTAL, 4.5"	5 BULK	AD
B-2	1280106-MALB	2-7/8" REGATTA PEDESTAL, 6"	5 BULK	AD

High-strength 2-7/8" black anodized pedestals with slide / swivel.

- Black anodize meets 500hr UV testing
- Same strength and material as our 2nd-Gen or Regatta pedestals



BLACK ANODIZED MAINSTAY PACKAGE



OEM IMAGE	PART NUMBER	DESCRIPTION	PACK QUANTITY	ABYC
A	1250456-LB	HEAVY-DUTY MAINSTAY PACKAGE	1 BULK	AD

2-7/8" Pedestal with 9" round base with rigid 4-keyed aluminum post.

- Air-powered height adjustment
- Anodized black finish
- Trac-Lock™ slide & swivel



2-7/8" SERIES

REGATTA PEDESTAL



A Anodized Finish

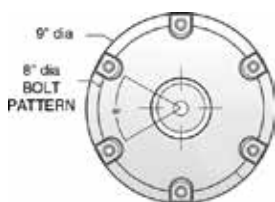

B Polished Finish

IMAGE	A	B	RETAIL	
HEIGHT	ANODIZED	POLISHED	PACK QUANTITY	ABYC
4.5"	1280104-SAL1	-	1 RETAIL	AD

Retail packed in box with 4-color label

IMAGE	A	B	OEM	
HEIGHT	ANODIZED	POLISHED	PACK QUANTITY	ABYC
4.5"	1280104-MAL	1280104-MPL	5 BULK	AD
6"	1280106-MAL	1280106-MPL	5 BULK	AD
7"	1280107-MAL	-	5 BULK	AD
8"	1280108-MAL	1280108-MPL	5 BULK	AD
9"	1280109-MAL	-	5 BULK	AD
10"	1280110-MAL	-	5 BULK	AD

IMAGE	C	C	OEM	
HEIGHT	ANODIZED	POLISHED	PACK QUANTITY	ABYC
4.5"	1281104-MAL	-	5 BULK	AD
4.5"	-	1282104-MPL	5 BULK	AD
6"	1281106-MAL	-	5 BULK	AD



C Flat Side

2-7/8" locking pedestal with 9" low-profile base combination. Permanent mold base is made from high magnesium aluminum for corrosion resistance. Hydro-formed for optimal rotational torque and welded for safety assurance.

- For use with any 2-7/8" locking Trac-Lock™ or Cam-Lock (sold separately)
- 14" max height for Regatta



SCHOONER PEDESTAL W/FLAT-SIDE



A

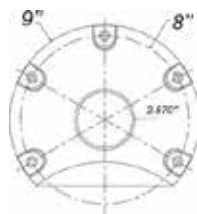

OEM IMAGE	PART NUMBER	FINISH	PACK QUANTITY	ABYC
A	1260605-MAL	ANODIZED	5 BULK	AD
A	1260606-DAL	ANODIZED	2 BULK	AD
A	1260607-MAL	ANODIZED	5 BULK	AD
A	1260610-DAL	ANODIZED	2 BULK	AD
A	1260615-DAL	ANODIZED	2 BULK	AD

2-7/8" Locking pedestal with 9" flat-side base combination in anodized finish.

- Use with 2-7/8" locking Trac-Lock™ slide or swivel (sold separately)
- Molded with one flat side for compartment access



EZ-RIDE WAVE DAMPENING

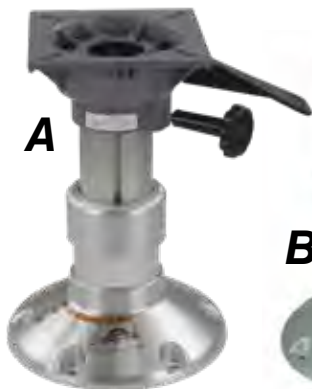

A

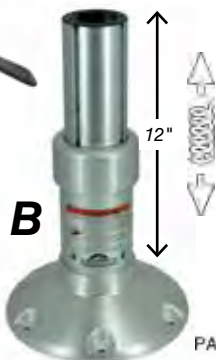

B



RETAIL IMAGE	PART NUMBER	DESCRIPTION	PACK QUANTITY	ABYC
A	1080136-L1	2-7/8" EZ-RIDE PEDESTAL PACKAGE	1 RETAIL	AD

Retail packed in box with 4-color label

OEM IMAGE	PART NUMBER	DESCRIPTION	PACK QUANTITY	ABYC
B	1080136	2-7/8" EZ-RIDE WAVE-DAMPENING PEDESTAL	1 BULK	AD

Internal gas shock within a mechanical spring provides a wave-dampening soft ride. 12" anodized aluminum pedestal with 9" round base, 3-1/2" outer post with 2-7/8" inner post and 4-keyed rotational locking collar covers bushing to restrict movement. Tested to ABYC H-31 dynamic static loads.

- Allows 3-1/2" of vertical travel
- Developed and intended for recreational in-shore use
- Additional height available upon request





- **MARINER II**
- **WORKHORSE**
- **ELITE**
- **MAINSTAY**

4" Series

SPRINGFIELD Marine introduces the 4" series, engineered for the most demanding work or pleasure boat applications. This heavy-duty series is designed to provide rugged service and wobble-free control, ensuring reliable performance in challenging conditions.

The 4" seat mounts include the Mariner II, Workhorse, and Elite Series. The 4" pedestals are available in the Mainstay and Elite Series, offering both fixed-height and adjustable options in various lengths and finishes. These pedestals are constructed from corrosion-resistant stainless steel or high-strength aluminum, ensuring durability and longevity in harsh marine environments.

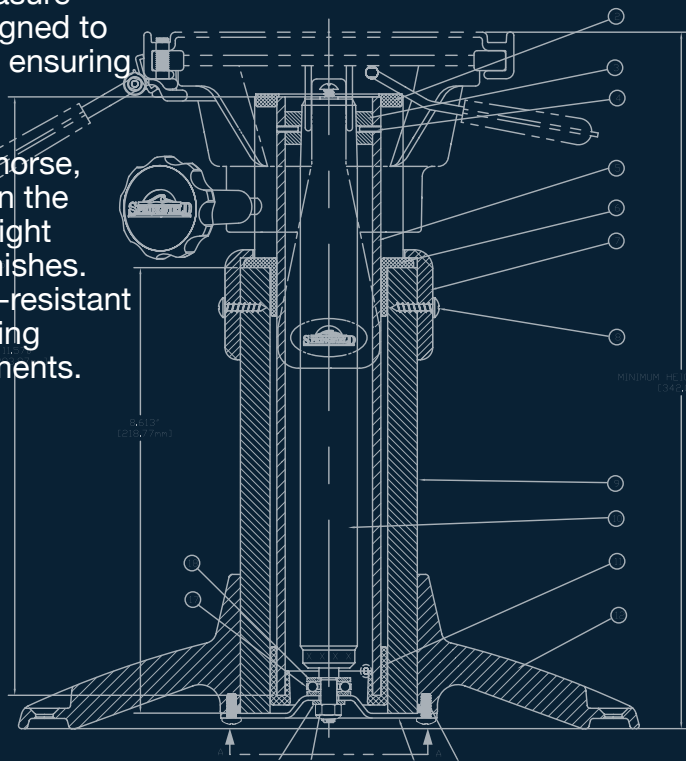

ELECTRIC MAINSTAY 4"



OEM IMAGE	PART NUMBER	DESCRIPTION	ADJUSTS	PACK QUANTITY	ABYC
A	1271340-PE	ALUMINUM PEDESTAL PACKAGE	17-1/4" to 22"	1 BULK	AD
A	1271349-PE	ALUMINUM PEDESTAL PACKAGE	24-1/4" to 32"	1 BULK	AD
A	1271353-PE	ALUMINUM PEDESTAL PACKAGE	27" to 35"	1 BULK	AD
B	1271640-SSE	STAINLESS STEEL PEDESTAL PACKAGE	17-1/4" to 22"	1 BULK	AD
B	1271649-SSE	STAINLESS STEEL PEDESTAL PACKAGE	24-1/4" to 32"	1 BULK	AD
C	1271333-PE	THRU-DECK PEDESTAL PACKAGE	14" to 18"	1 BULK	AD
C	1271334-PE	THRU-DECK PEDESTAL PACKAGE	18" to 26"	1 BULK	AD
C	1271353-PE	THRU-DECK PEDESTAL PACKAGE	27" to 35"	1 BULK	AD

4" diameter outer post with 3-1/2" inner post and 4" collar. Thick wall construction for maximum durability. 12" base with 11" hole pattern. Electric powered height adjustment. Lifts 500 lbs.

PACKAGE INCLUDES:

- Electrical pedestal
- Mariner II 3100565-LAE slide & swivel
- Switches and switch box



(A & C) Made from high-strength polished aluminum
(B) Made from 316 stainless steel with #8 mirror finish

MARINER II SLIDE / SWIVEL

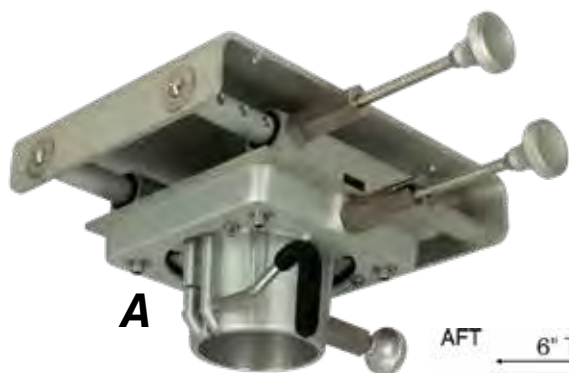

OEM IMAGE	PART NUMBER	DESCRIPTION	FINISH	PACK QUANTITY	ABYC
A	3100565-LA	LOCKING SLIDE & SWIVEL	ANODIZED	1 BULK	AD
A	3100565-LARA	AIR-RIDE SLIDE & SWIVEL	ANODIZED	1 BULK	AD

10-1/2" x 14-1/2" x 1/4" aluminum formed slide plate. Swivel clamps and locks onto a 4" post with stainless steel pin and rotates internally on 1/2" HDPE bearing for smooth operation in any position. Anodized aluminum.

- Travels 6" fore and aft
- Adds 3-7/8" to height of pedestal
- Locks in 8 positions

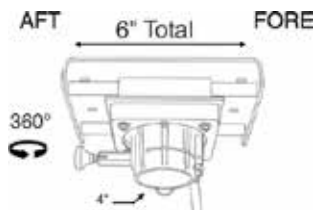

4" SERIES

MARINER II SWIVEL



Swivel Only - Centered

OEM IMAGE	PART NUMBER	DESCRIPTION	PACK QUANTITY	ABYC
A	3100065-L	MARINER II LOCKING SWIVEL	1 BULK	AD
A	3100065-L2	MARINER II LOCKING SWIVEL OFFSET	1 BULK	AD

Large high-strength aluminum mounting plate. Swivel clamps and locks onto a 4" post with stainless steel pin and rotates internally on 1/2" HDPE bearing for smooth operation in any position.

- Swivels on bearing
- Locks in 8 positions



WORKHORSE SLIDE / SWIVEL



OEM IMAGE	PART NUMBER	DESCRIPTION	FINISH	PACK QUANTITY	ABYC
A	3100075-L	SWIVEL ONLY	ANODIZED	1 BULK	AD
B	3100075-LAR	AIR-RIDE SWIVEL ONLY	ANODIZED	1 BULK	AD
C	3100575-LAR	AIR-RIDE SLIDE & SWIVEL	ANODIZED	1 BULK	AD
D	3100575-L	SLIDE & SWIVEL	ANODIZED	1 BULK	AD

10-1/2" x 14-1/2" x 1/4" aluminum formed slide plate.
Heavy-duty stainless steel lock pin. Anodized aluminum.

- Large easy-to-reach control knobs
- Swivels on post
- Slide travels 6" fore and aft
- Flip handle for locking pin

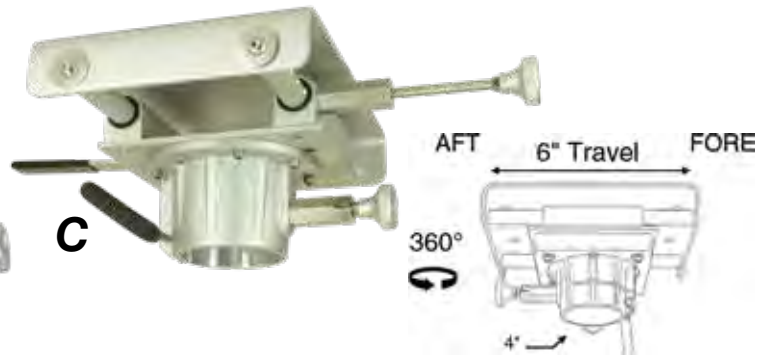

LOW-PROFILE WORKHORSE SLIDE / SWIVEL



OEM IMAGE	PART NUMBER	DESCRIPTION	PACK QUANTITY	ABYC
A	3100656-01	LOW-PROFILE SLIDE & SWIVEL W/4" MOUNT	1 BULK	AD
	3100657-LAR*	LOW-PROFILE AIR-RIDE SLIDE & SWIVEL	1 BULK	AD
B	3100676-L	LOW-PROFILE SLIDE W/4" SWIVEL	1 BULK	AD
C	3100675-L	HEAVY-DUTY TOWEL BAR SLIDE W/4" SWIVEL	1 BULK	AD

Low-profile slide with front activated towel bar handle for slide activation mounted to 4" workhorse swivel. Anodized aluminum.

- Short low-profile used on bolster seats
- Mounts to any 4" seat pedestal



ELITE SLIDE / SWIVEL



OEM IMAGE	PART NUMBER	DESCRIPTION	FINISH	PACK QUANTITY	ABYC
A	3100460-LE1	ELITE SLIDE & SWIVEL	ANODIZED	4 BULK	AD

8-1/4" x 13" seat mounting platform. Anodized slide and polish post mount fits over 4" pedestals, locks and tightens securely to prevent wobble. Large pivot area ensures stability.

- Rotates 360°
- Slide travels 5-3/8" fore and aft
- Adds 1-1/2" to height of pedestal

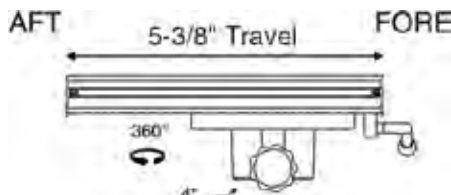

BLACK ANODIZED LP PEDESTAL, SLIDE / SWIVEL



OEM IMAGE	PART NUMBER	DESCRIPTION	FINISH	PACK QUANTITY	ABYC
A	3100656-01B	LOW-PROFILE SLIDE & SWIVEL ON 4" MOUNT	BLACK ANODIZED	1 BULK	AD
B	1450012-BLK	4" ELITE FIXED-HEIGHT PEDESTAL	BLACK ANODIZED	1 BULK	AD

Low profile black anodized slide / swivel rotates on bushing and slides on rails with forward controls.

- Available in a range of heights (special order)



CENTER FLOOR SLIDE

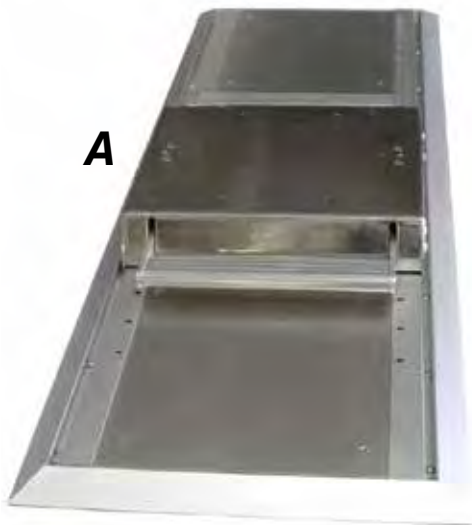

RETAIL IMAGE	PART NUMBER	DESCRIPTION	FINISH	PACK QUANTITY	ABYC
A	3100550-SS	CENTER FLOOR SLIDE	STAINLESS STEEL	1 BULK	AD

Allows seat to move easily up to 35-1/2" side-to-side between stations. Platform with pre-drilled holes to accept standard 12" base.

- Dimensions: 19" x 53.4" x 3.75"



*SEAT AND PEDESTAL PACKAGE SOLD SEPARATELY.

ALUMINUM ADJUSTABLE MAINSTAY PEDESTAL

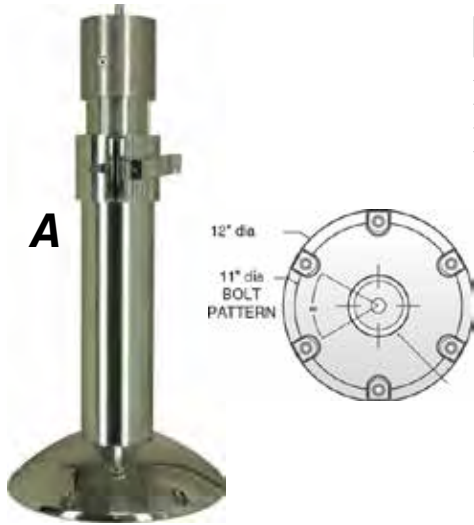

OEM IMAGE	PART NUMBER	ADJUSTS	MATERIAL / FINISH	PACK QUANTITY	ABYC
A	1270340-P	13-1/2" to 18"	POLISHED FINISH	1 BULK	AD
A	1270343-P	16" to 20-1/2"	POLISHED FINISH	1 BULK	AD
A	1270346-P	18" to 28"	POLISHED FINISH	1 BULK	AD
A	1270350-P	22" to 32"	POLISHED FINISH	1 BULK	AD
A	1270354-P	26" to 36"	POLISHED FINISH	1 BULK	AD

4" adjustable pedestal with 12" round base. 650 Newton air cylinder provides height adjustment.

- Use with any 4" Mariner II or Workhorse slide or swivel (sold separately)
- Cast base, high-grade alloy with hand polished finish



ELITE FIXED-HEIGHT PEDESTAL

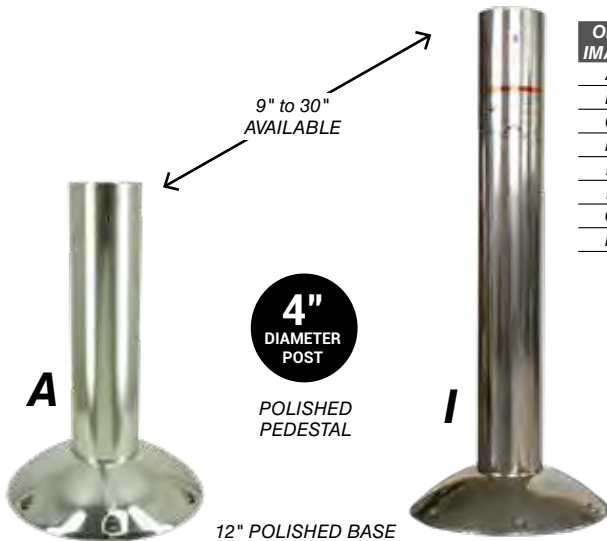

OEM IMAGE	PART NUMBER	ADJUSTS	FINISH	PACK QUANTITY	ABYC
A	1450009-A	9"	ANODIZED	1 BULK	AD
B	1450009-P	9"	POLISHED	1 BULK	AD
C	1450012-P	12"	POLISHED	1 BULK	AD
D	1450014-P	14"	POLISHED	1 BULK	AD
E	1450018-P	18"	POLISHED	1 BULK	AD
F	1450022-P	22"	POLISHED	1 BULK	AD
G	1450024-P	24"	POLISHED	1 BULK	AD
H	1450028-P	28"	POLISHED	1 BULK	AD
I	1450030-P	30"	POLISHED	1 BULK	AD

4" aluminum pedestal with 12" round base, available in polished or anodized (9" only). Pedestal is sized and pressed into base then rim welded for stability.

- Posts are .213" thick aluminum
- Use with any 4" Mariner II or Workhorse slide or swivel (sold separately)
- Cast base, high alloy with hand polished finish

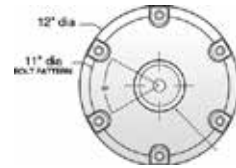

STAINLESS STEEL PEDESTAL

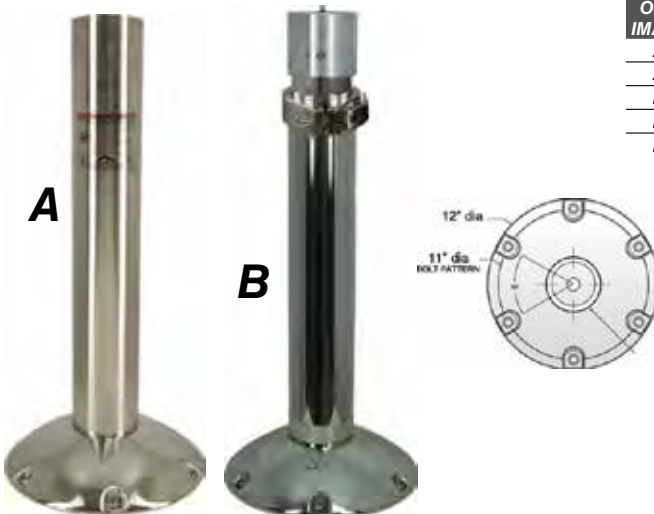

OEM IMAGE	PART NUMBER	ADJUSTS	FINISH	PACK QUANTITY	ABYC
A	1450626-SSP	26"	316 SS	1 BULK	AD
A	1450630-SSP	30"	316 SS	1 BULK	AD
B	1270640-SS	13-1/2" to 18"	316 SS	1 BULK	AD
B	1270646-SS	18" to 28"	316 SS	1 BULK	AD
B	1270650-SS	22" to 32"	316 SS	1 BULK	AD

4" locking fixed-height or adjustable pedestal with 12" round base. 316 stainless steel with #8 mirror finish. Rim welded to provide maximum strength

- Available in a variety of heights
- Use with any 4" seat mount (sold separately)
- Use with any 4" Mariner II or Workhorse slide or swivel (sold separately)
- 650 Newton cylinder



4" EZ-RIDE PEDESTAL



OEM IMAGE	PART NUMBER	DESCRIPTION	FINISH	HEIGHT	MOUNT	PACK QUANTITY	ABYC
A	1080117	EZ-RIDE PEDESTAL	POLISHED	17"	SURFACE	1 BULK	AD
B	1080111-02	EZ-RIDE PEDESTAL	SATIN ANODIZED	15.5"	THRU-DECK	1 BULK	AD

Retail packed in box with 4-color label

Proven mechanical spring and shock technology in a traditional pedestal configuration. Thick wall (.213) post allows 5-1/2" of vertical travel.

- 500kg/175lbs per inch rating (A)
- Polished brite dip aluminum pedestal with 12" round base (B)
- Thru-deck requires 8" below deck (B)

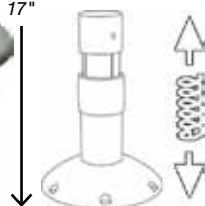

Wave dampening pedestal reduces the impact caused by harsh waves.



OFFSHORE 4" PACKAGE



RETAIL IMAGE	PART NUMBER	DESCRIPTION	PACK QUANTITY	ABYC
A	1457545	4" FIXED-HEIGHT HELM PEDESTAL PACKAGE	1 RETAIL	AD

Retail packed in box with label

Heavy-duty 4" Workhorse slide & swivel with anodized finish. 4" fixed-height brite dip pedestal with 12" round floor base. Helmsman flip-up footrest flips up out of the way.

- 24" Fixed-height pedestal
- Overall height 27-1/2"

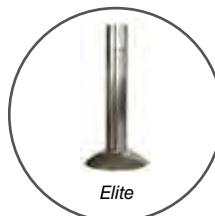

OFFSHORE 4" ADJUSTABLE



RETAIL IMAGE	PART NUMBER	DESCRIPTION	PACK QUANTITY	ABYC
A	1276548	4" AIR-RIDE HELM PEDESTAL PACKAGE	1 RETAIL	AD

Retail packed in box with label

Heavy-duty 4" air-ride Mariner II slide & swivel with anodized finish. 4" fixed-height brite dip pedestal with 12" round polished floor base. Seat mounting footrest offers adjustable height and flips-up out of the way.

- Pedestal adjusts 18" to 28"
- Overall height 22" to 32"
- 650 Newton cylinder

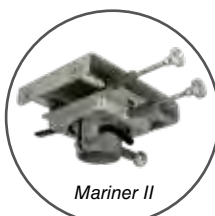

IN-SHORE LE1 PACKAGE



RETAIL IMAGE	PART NUMBER	DESCRIPTION	PACK QUANTITY	ABYC
A	1255595-NC	IN-SHORE LE1 PEDESTAL PACKAGE	1 RETAIL	AD

Heavy-duty adjustable mainstay package includes locking Trac-Lock™ air-ride slide & swivel. Half-round stainless steel footrest, 316 electro-polished stainless steel. Black powder-coated 5-legged deck base.

- Pedestal adjusts 13-1/2" to 19"
- Overall height 20" to 27"

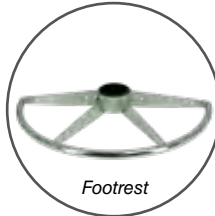

IN-SHORE RS2 PACKAGE



RETAIL IMAGE	PART NUMBER	DESCRIPTION	PACK QUANTITY	ABYC
A	1455580-NC	IN-SHORE RS2 PEDESTAL PACKAGE	1 RETAIL	AD

Locking Workhorse swivel mount with anodized finish. 4" fixed-height pedestal with 12" round floor base and high-strength polished aluminum finish. 316 electro-polished stainless steel 28" round footrest. Black powder-coated 5-legged deck base.

- 18" Fixed-height pedestal
- Overall height 25-1/2"



IN-SHORE LX2 PACKAGE



RETAIL IMAGE	PART NUMBER	DESCRIPTION	PACK QUANTITY	ABYC
A	1275580-NC	IN-SHORE LX2 PEDESTAL PACKAGE	1 RETAIL	AD

Air-ride locking Workhorse swivel mount with anodized finish. 4" pedestal with 12" round base and high-strength polished aluminum finish. 28" round footrest, 316 electro-polished stainless steel. Black powder-coated 5-legged deck base.

- Pedestal adjusts 13-1/2" to 18"
- Overall height 23" to 27-1/2"





- SEAT MOUNTS
- SEATS
- AFTERMARKET
- ACCESSORIES

Shark Seating

SPRINGFIELD Marine introduces SHARK Seating. A lightweight, affordable, suspension seating system. What does S H A R K stand for?

SAFETY: was the founding premise of Shark, with our primary goal being to reduce the risks to boaters from wave impacts. Our designs are human-centric, designed to work intuitively, ergonomically and in harmony with every aspect of human nature, even in harsh environments.

HONESTY: is a core value: We remain true to our humble, straight-forward and friendly New Zealand origins while emphasizing safety, fun and freedom.

AFFORDABILITY: is our middle name. We make first-class protection accessible to all boaters (recreational, first responder, commercial, and defense) with suspensions that are the most affordable on the market.

RELIABILITY: is a key attribute that Shark emphasizes to meet the needs of our customers and team members. We do this by making elegantly simple and durable products, which are well stocked and supported in every market and sector.

KUDOS: Shark Seating utilizes ergonomic design principles to effectively disperse kinetic energy. Engineered products that are elegantly simple and durable ensure our seating solutions perform reliably across every market and sector.

FLEX suspension range

FLEX provides 225mm of ultra-smooth travel that is completely corrosion-proof, light, and tough.

Combined with our stainless steel shock absorber, there are no pinch points or sharp edges and it will withstand 10g impacts making it safe in every way!

FLEX-pod

Super light and super compact

Only
3.3kg!



Picture shows **FLEX-pod** fully compressed



FLEX-pod brings 2/3rd of **FLEX** performance but in a package 1/3rd the weight and 1/2 the height. That's 150mm of vertical travel in the smallest possible size to not only save your back but save space and money at the same time.

FLEX



Transforms any seat for a softer safer ride



FLEX-HD

Rated for 10G vertically and 6G (impact) horizontally when used with seatbelts

Adjustable plinths



A2 (alloy)
Fastenings: M8 x 8, 316 SS
Weight: 3.95 kg

200mm → 300mm

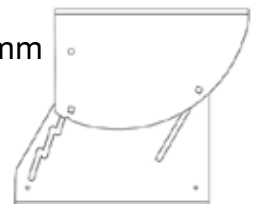

seat + suspension range

ULTRA



The starting point for every shark seat

NEW ULTRA-lite

Available with
EPIC Cover



Weighs only 7kg and fits
in even tighter spaces

2024 EPIC

NEW: Rugged
Rear Handgrip



French-stitched marine-grade leatherette
in custom colors with rear hand grip

LUXE



The most complete seat that features
all jockey accessories

Aftermarket seats & accessories



For *FLEX*-pod HD plates



Material: Alloy
Weight: 1kg



For *ULTRA* Jockey seat covers

FLEX

ULTRA



Material: Nylon
Weight: 0.5kg

Normal
Orientation



Reflex
Orientation



**For a range of other seat options, accessories,
and ordering—consult your local shark dealer.**

TRAX system

Floor plate +

Is a great retrofit as it covers all your old fixing holes and trim

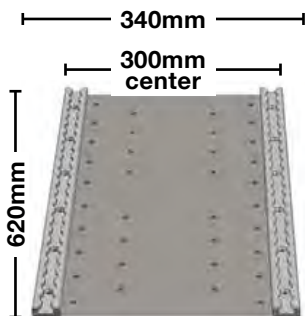

Material: Alloy
Weight: 3kg

Rails +

For boat builders to arrange seats in rows

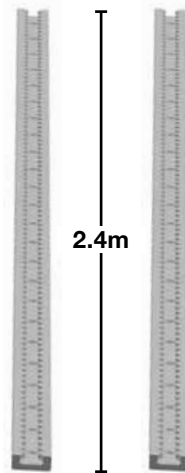

Material: Alloy
Weight: 3kg

Adaptor =

This plate allows your to quick-mount your plinth, suspension or seat to shark TRAX



Material: Alloy
Weight: 1.38kg

TRAX

Allows any shark product to slide and quick-mount in any position



20mm added height

Material: Alloy
Weight: 4.38kg

Accessories: For *ULTRA*, *EPIC* and *LUXE*

Lap belt / 4-pt harness

Stainless steel aircraft style lap belt



Material: 316SS / n/a
Weight: 330g / 2kg

Side grips

Additional stability for passengers behind these seats



Material: Injection molded plastic
Weight: 135g

Basket ^{NEW}

Allows for easy access storage behind the seat



Material: Waterproof fabric
Weight: 220g

Jockey swivel

Allows for 360° rotation at 90° degree increments with front pull



Material: Alloy
Weight: 1.5kg



- **BENCH SLIDES**
- **SWIVELS**
- **SEAT CLAMPS**
- **MOUNTING PLATES**
- **SLIDE RAILS**
- **PEDESTALS**

Mounting Systems

SPRINGFIELD Marine offers a wide range of mounting systems designed for low-profile decks. These systems incorporate features such as both swivel and slide functionalities, making them suitable for passenger and driver's seat positions. Additionally, we provide a variety of recreational systems tailored for Jon Boats and other small crafts.

All our systems are ABYC H-31 A and B rated, ensuring they meet the highest standards for safety and performance.

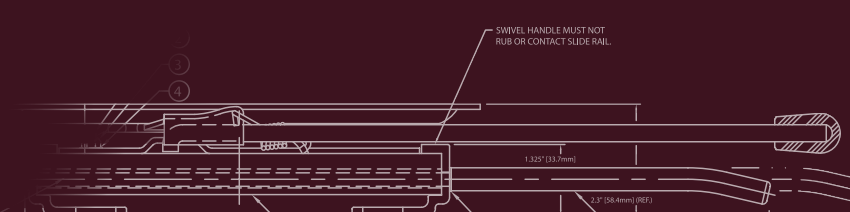
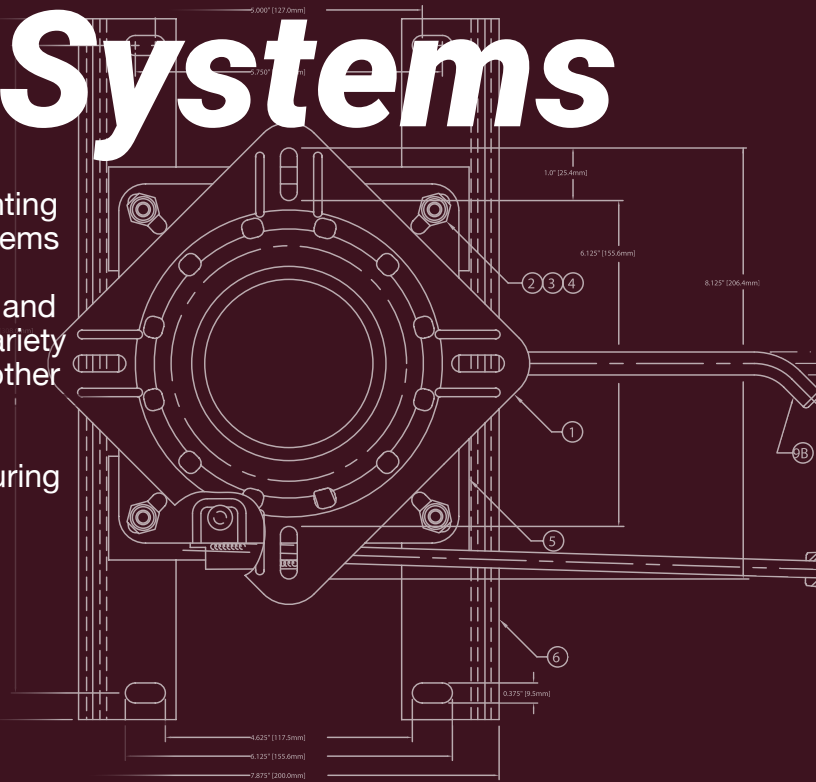

TRU-LOCK 1000

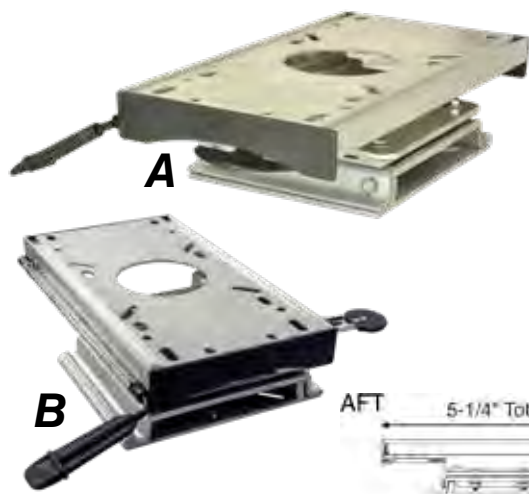

RETAIL		IMAGE	PART NUMBER	DESCRIPTION	PACK QUANTITY	ABYC
A			1100360	TRU-LOCK 1000 SLIDE & SWIVEL	1 RETAIL	AD

Retail packed in box with label

OEM		IMAGE	PART NUMBER	DESCRIPTION	PACK QUANTITY	ABYC
A			3100360	TRU-LOCK 1000 SLIDE & SWIVEL	8 BULK	AD
B			3100360-EXTL	TRU-LOCK 1000 LEFT EXTENDED HANDLE	8 BULK	AD

Large 7-1/4" x 13" x 3-1/2" platform travels 5-1/4" fore and aft with 8 locking positions. Large pivot area for stability. Easy to install and remove with separate lower mounting plate.

- Rotates 360°
- Pivot handle rotates with chair
- 4" x 5-5/8" mounting pattern
- Universal seat mounting pattern: 5" x 5" & 5" x 12"

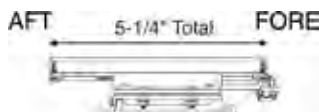

HEAVY-DUTY FRONT LEVER & ELECTRIC SLIDE

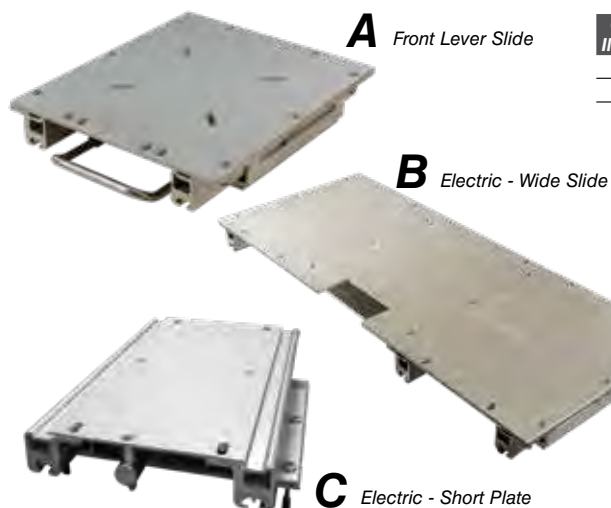

OEM		IMAGE	PART NUMBER	DESCRIPTION	PACK QUANTITY	ABYC
A			3100545	FRONT LEVER HEAVY-DUTY SLIDE	4 BULK	AD
B			3100545-EW	HEAVY-DUTY 52" WIDE, ELECTRIC SLIDE	1 BULK	AD
C			3100544-E1	HEAVY-DUTY 4" SHORT PLATE, ELECTRIC SLIDE	1 BULK	AD

(A) FRONT LEVER SLIDE:

- High-strength anodized aluminum construction
- Travels 6" fore and aft on heavy-duty rails
- Double latch towel bar slide, includes top and bottom mounting plates

(B & C) ELECTRIC HEAVY-DUTY SLIDE:

- High-strength anodized aluminum construction
- Electric motor operates on 12V DC power
- Smooth and quiet operation



LOW-PROFILE SLIDES

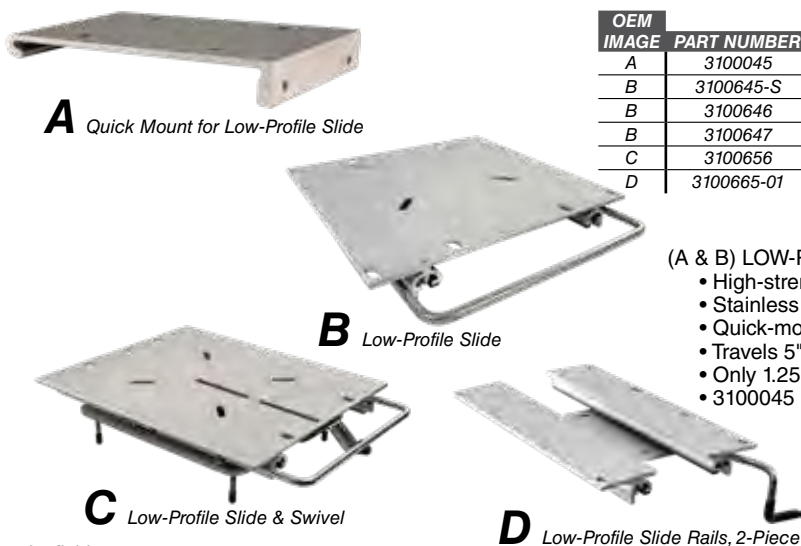

OEM		IMAGE	PART NUMBER	DESCRIPTION	PACK QUANTITY	ABYC
A			3100045	QUICK-MOUNT FOR LOW-PROFILE SLIDE	10 BULK	-
B			3100645-S	LOW-PROFILE SLIDE SHORT W/MOUNT	10 BULK	AD
B			3100646	LOW-PROFILE SLIDE	10 BULK	AD
B			3100647	LOW-PROFILE SHORT HANDLE W/MOUNTING PLATE	10 BULK	AD
C			3100656	LOW-PROFILE SLIDE & SWIVEL	4 BULK	AD
D			3100665-01	LOW-PROFILE SLIDE RAILS 2-PIECE	10 BULK	AD

(A & B) LOW-PROFILE SLIDE & QUICK-MOUNT:

- High-strength anodized aluminum construction
- Stainless steel front activation handle bar
- Quick-mount for easy installation
- Travels 5" fore and aft
- Only 1.25" thick
- 3100045 MOUNT & 3100646 SLIDE work together



MOUNTING SYSTEMS

UNIVERSAL TRAC-LOCK™ SLIDE



RETAIL IMAGE	PART NUMBER	DESCRIPTION	PLATE	PACK QUANTITY	ABYC
A	1100300	UNIVERSAL TRAC-LOCK™ SLIDE	10.187" x 7.25"	6 RETAIL	AD

Retail packed in clamshell with 4-color label

OEM IMAGE	PART NUMBER	DESCRIPTION	PLATE	PACK QUANTITY	ABYC
A	3100300	UNIVERSAL TRAC-LOCK™ SLIDE	10.187" x 7.25"	10 BULK	AD
A	3100300-M	UNIVERSAL TRAC-LOCK™ SLIDE, MODIFIED	13" x 7.25"	10 BULK	AD
-	3100300-SM	UNIVERSAL TRAC-LOCK™ SLIDE, SHORT, MOD	10.187" x 7.25"	10 BULK	AD
-	3100300-05	UNIVERSAL TRAC-LOCK™ SLIDE, SHORT	10.187" x 7.25"	10 BULK	AD
-	3100300-06	UNIVERSAL TRAC-LOCK™ EXTRA LONG, TRVL	15.06" x 7.25"	10 BULK	AD

Large 7-1/4" x 13" platform travels 5-1/4" fore and aft. High-strength anodized aluminum. Can be used as box or pedestal mount.

- Adds 2" to height of pedestal
- Universal mounting pattern: 5" x 5" slotted
- Versatile seat mounting solution for flat surfaces and pedestals
- Key hole modified mounting pattern (#3100300-SM, #3100300-M only)



QUICK SEAT MOUNT

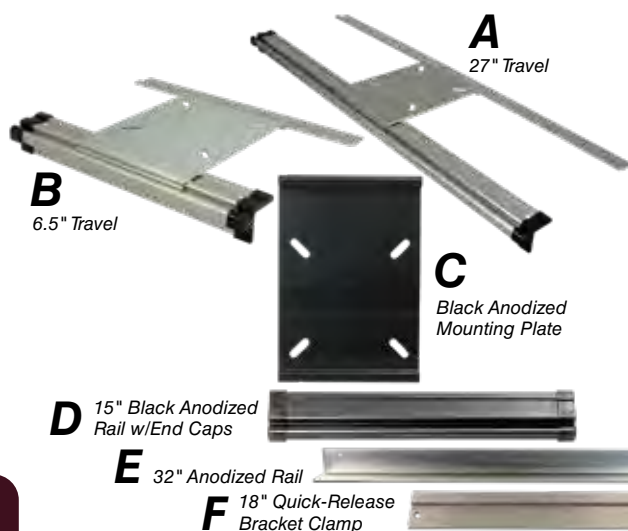

RETAIL IMAGE	PART NUMBER	DESCRIPTION	PACK QUANTITY	ABYC
A	1100016	QUICK SEAT MOUNT & RAILS, 35" RAIL	6 RETAIL	AD
B	1100017	QUICK SEAT MOUNT & RAILS, 14-3/4" RAIL	6 RETAIL	AD

Retail packed in box with 4-color label

OEM IMAGE	PART NUMBER	DESCRIPTION	PACK QUANTITY	ABYC
C	3100036	QUICK-RELEASE SEAT MOUNT, ANODIZED	20 BULK	AD
C	3100036-BLK	QUICK-RELEASE SEAT MOUNT, BLACK ANODIZED	20 BULK	AD
D	3100038-BLK	15" BLACK ANODIZED RAIL W/END CAPS	20 BULK	AD
E	3100037	32" ANODIZED RAIL	20 BULK	AD
E	3100039	44" SATIN ANODIZED RAIL ONLY	20 BULK	AD
F	3100034	18" QUICK-RELEASE BRACKET CLAMP	20 BULK	AD

Easy to install and remove from boat. Bracket allows seat to slide side-to-side for comfort and convenience. Locking mechanism prevents tipping forward in sudden stop situations. Commonly used on Tiller style boats.



UNIVERSAL MOUNTING PLATE



OEM IMAGE	PART NUMBER	DESCRIPTION	PACK QUANTITY
A	3100207	MOUNTING PLATE	10 BULK

Adapts a swivel mount to fit most seat mount patterns. High-strength aluminum. Use with any Springfield® marine swivel. Adds structural support to rotational molded seats and other plastic seat bottoms.

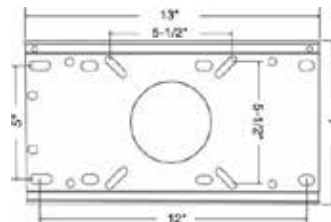

MOUNTING SYSTEMS

SEAT SUSPENSION SYSTEM



RETAIL		IMAGE	PART NUMBER	DESCRIPTION	PACK QUANTITY	ABYC
A			1840220	SEAT SUSPENSION SYSTEM	6 RETAIL	B

Retail packed in box with 4-color label

OEM		IMAGE	PART NUMBER	DESCRIPTION	PACK QUANTITY	ABYC
A			3840220	SEAT SUSPENSION SYSTEM	10 BULK	B

7" x 8-1/2" x 2-1/2" high-strength aluminum. Heavy-duty springs provide a comfortable ride.

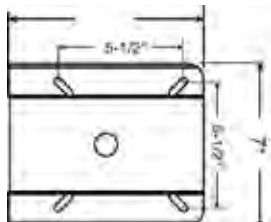

SLIDE RAILS

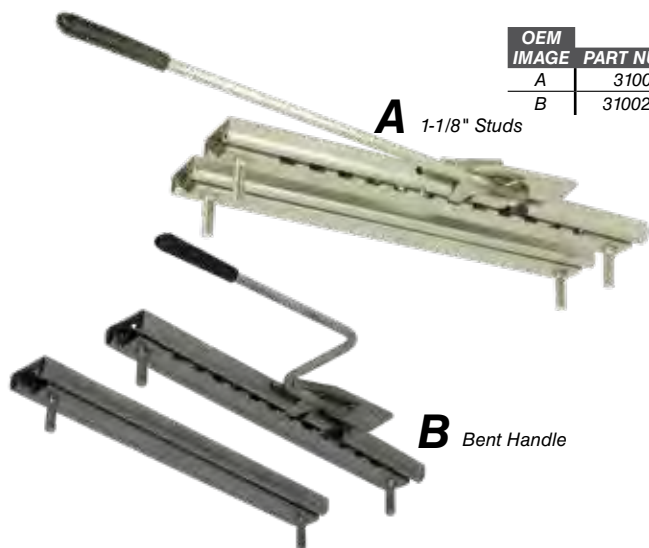

OEM		IMAGE	PART NUMBER	DESCRIPTION	PACK QUANTITY	ABYC
A			3100205	2-PIECE CHAIR SLIDE RAILS	10 BULK	AD
B			3100205-M	2-PIECE CHAIR SLIDE RAILS - BENT HANDLES	10 BULK	AD

Stainless steel slide rails are available as a 2-piece set with straight or bent handle.

- Includes 1-1/8" mounting studs
- Slide rails travel 6" fore and aft



HEAVY-DUTY SLIDE RAILS

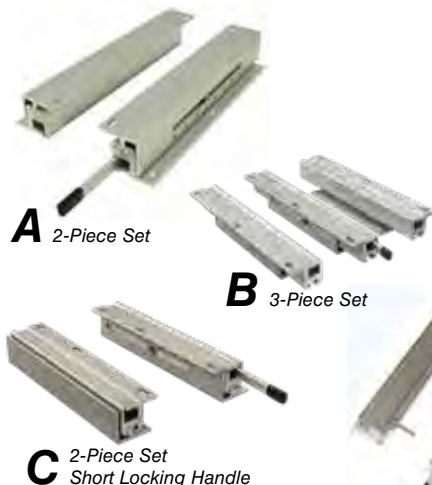

OEM IMAGE	PART NUMBER	DESCRIPTION	TRAVEL	STUDS	PACK QUANTITY	ABYC
A	3100534-L	2-PIECE SLIDE RAILS, LOCKING	4"	-	10 BULK	AD
B	3100534-L3M	3-PIECE SLIDE RAILS, LOCKING	4"	-	10 BULK	AD
C	3100534-LSH	2-PIECE SLIDE RAILS, SHORT	4"	-	10 BULK	AD
D	3100534-S	2-PIECE SLIDE RAILS, LOCKING	4"	INCLUDED	10 BULK	AD
E	3100537-L3	3-PIECE SLIDE RAILS, LOCKING	5"	-	10 BULK	AD
F	3100548	2-PIECE SLIDE RAILS, NON-LOCKING	7"	-	10 BULK	AP
G	3100665-01	LOW-PROFILE 2-PIECE SLIDE RAILS, LOCKING	7"	-	10 BULK	AD

Slide rails for large seats anywhere in the boat. High-strength aluminum to withstand all conditions.

- Travels 7" fore and aft



D 2-Piece Set w/Studs

E 3-Piece Set

F 2-Piece Non-Locking

G Low-Profile 2-Piece Locking

MOUNTING SYSTEMS

UNIVERSAL TRAC-LOCK™ SLIDE

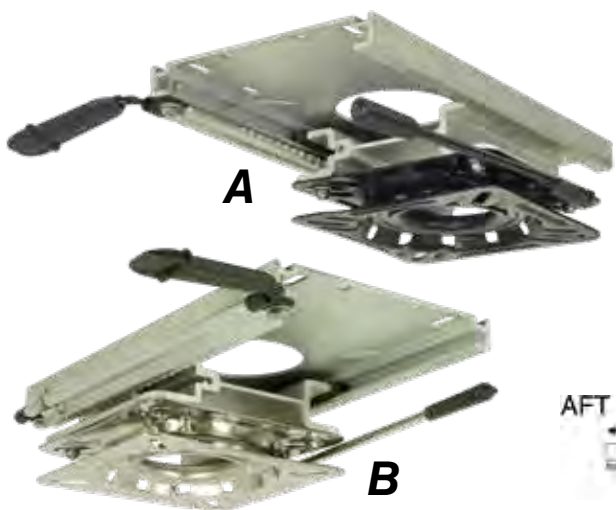

RETAIL IMAGE	PART NUMBER	DESCRIPTION	PACK QUANTITY	ABYC
A	1100318	UNIVERSAL WITH E-COAT SWIVEL	1 RETAIL	AD
B	1100319	UNIVERSAL W/STAINLESS STEEL SWIVEL	1 RETAIL	AD

Retail packed in clamshell with 4-color label

OEM IMAGE	PART NUMBER	DESCRIPTION	PACK QUANTITY	ABYC
A	3100318	UNIVERSAL WITH E-COAT SWIVEL	10 BULK	AD
B	3100319	UNIVERSAL W/STAINLESS STEEL SWIVEL	10 BULK	AD

Large 7-1/4" x 13" X 3" platform travels 5-1/2" fore and aft. Mounted 12-way swivel rotates 360°. Swivel available in mild steel with e-coat finish or stainless steel.

• Patent #5,782,451

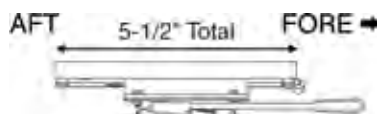

12-WAY LOCKING SWIVEL

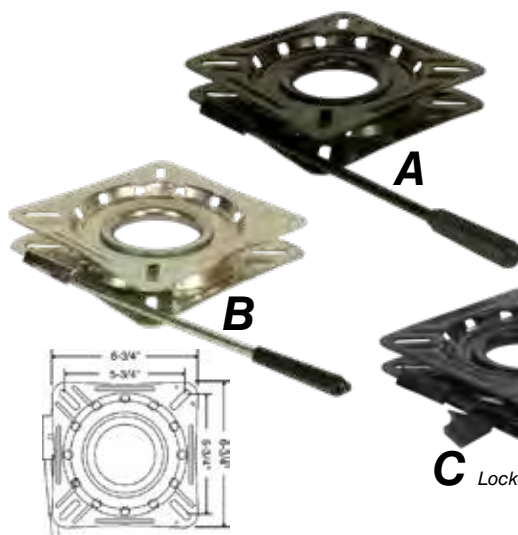

RETAIL IMAGE	PART NUMBER	DESCRIPTION	FINISH	PACK QUANTITY	ABYC
A	1100018	0-DEGREE LOCKING SWIVEL	E-COAT	6 RETAIL	AD
B	1100019	0-DEGREE LOCKING SWIVEL	STAINLESS STEEL	6 RETAIL	AD

Retail packed in box with 4-color label

OEM IMAGE	PART NUMBER	DESCRIPTION	FINISH	PACK QUANTITY	ABYC
C	3100018-01	LOCKOUT SEAT SWIVEL	E-COAT	20 BULK	AD
A	3100018	0-DEGREE LOCKING SWIVEL	E-COAT	20 BULK	AD
B	3100019	0-DEGREE LOCKING SWIVEL	STAINLESS STEEL	20 BULK	AD

6-3/4" square with 4-hole mounting pattern. Locking swivel rotates 360°. Available in stainless steel or e-coat finish.

- Handle length: 6.5"
- Kayak swivel for paddling then lockout for fishing (# 310018-01)
- Patent #5,782,451



NON-LOCKING SWIVEL



RETAIL IMAGE	PART NUMBER	DESCRIPTION	FINISH	PACK QUANTITY	ABYC
A	1100007	0-DEGREE NON-LOCKING SWIVEL	E-COAT	6 RETAIL	B
B	1100009	0-DEGREE NON-LOCKING SWIVEL	STAINLESS STEEL	6 RETAIL	B
C	1100007-PDQ*	7" x 7" SQUARE SWIVEL	E-COAT	6 RETAIL	B

Retail packed in box with 4-color label

OEM IMAGE	PART NUMBER	DESCRIPTION	FINISH	PACK QUANTITY	ABYC
A	3100007	0-DEGREE NON-LOCKING SWIVEL	E-COAT	20 BULK	B
B	3100009	0-DEGREE NON-LOCKING SWIVEL	STAINLESS STEEL	20 BULK	B

6-3/4" square with 4-hole mounting pattern. 0-degree non-locking swivel rotates 360°. Available in stainless steel or e-coat finish.

*110007-PDQ: packed 6 to shelf tray for retail.



MOUNTING SYSTEMS

PRO-TILT SEAT MOUNT

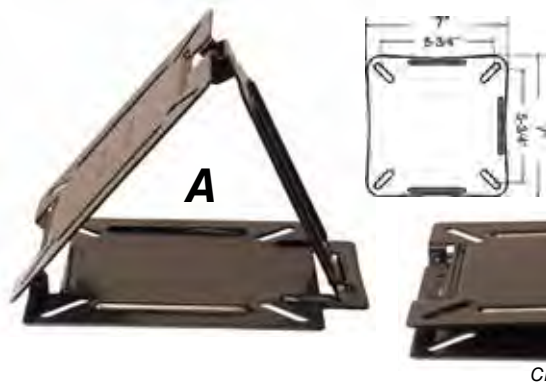

RETAIL IMAGE	PART NUMBER	DESCRIPTION	FINISH	PACK QUANTITY	ABYC
A	1780010	PRO-TILT SEAT MOUNT	E-COAT	6 RETAIL	B

Retail packed in box with 4-color label

7" x 7" seat mount with 4 mounting holes with spring-loaded locking mechanism E-coated mild steel to resist corrosion.
 • Tilt angles: 3°, 15°, 25°, 30°, 40°, 50°



REMOVABLE 7" X 7" SEAT BRACKET

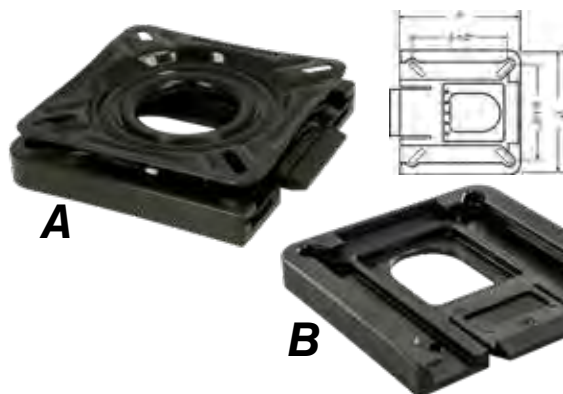

RETAIL IMAGE	PART NUMBER	DESCRIPTION	PACK QUANTITY	ABYC
A	1100115	REMOVABLE SEAT BRACKET & SWIVEL	6 RETAIL	B
B	1100015	REMOVABLE SEAT BRACKET 7" x 7"	6 RETAIL	B

Retail packed in clamshell with 4-color label

OEM IMAGE	PART NUMBER	DESCRIPTION	PACK QUANTITY	ABYC
B	3100015-1	REMOVABLE SEAT BRACKET 7" x 7"	20 BULK	B

7" x 7" removable seat bracket and non-locking seat swivel that rotates 360°. E-coated steel swivel to resist corrosion.



HEAVY-DUTY SEAT SWIVEL

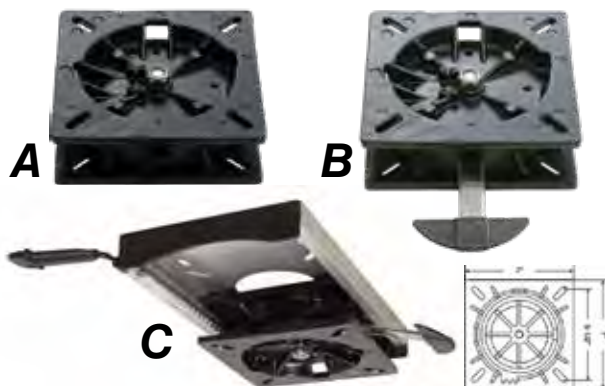

RETAIL IMAGE	PART NUMBER	DESCRIPTION	PACK QUANTITY	ABYC
A	1100050	NON-LOCKING SWIVEL	6 RETAIL	B
B	1100050-L	LOCKING SWIVEL	6 RETAIL	AD
C	1100550-L	LOCKING SLIDE & SWIVEL	1 RETAIL	AD

Retail packed in box with 4-color label

OEM IMAGE	PART NUMBER	DESCRIPTION	PACK QUANTITY	ABYC
A	3100050	NON-LOCKING SWIVEL	20 BULK	B
B	3100050-L	LOCKING SWIVEL	20 BULK	AD
C	3100550-L	LOCKING SLIDE & SWIVEL	10 BULK	AD

7" x 7" swivel with 4-hole mounting pattern, rotates 360°. Swivel travels 5-1/4" fore and aft. Powder-coat finish to resist corrosion.



JON BOAT SEAT CLAMP

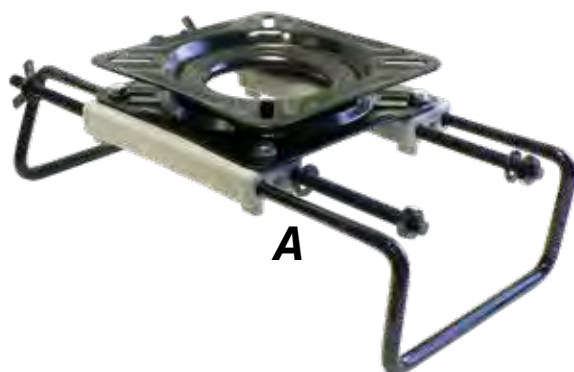

RETAIL IMAGE	PART NUMBER	DESCRIPTION	ADJUSTS	PACK QUANTITY	ABYC
A	1100012	ECONOMY SEAT CLAMP	8" to 19"	6 RETAIL	B
B	1104010	JON BOAT SEAT CLAMP	8" to 20-1/2"	6 RETAIL	B
C	2100097	JON BOAT SAFETY CLIP	-	1 RETAIL	-

Retail packed in clamshell with 4-color label



MOUNTING SYSTEMS

ECONOMY PEDESTAL



RETAIL IMAGE	PART NUMBER	DESCRIPTION	HEIGHT	FINISH	PACK QUANTITY	ABYC
C	1561105	ECONOMY FIXED-HEIGHT PEDESTAL	7"	E-COAT	6 RETAIL	B
A	1561106	ECONOMY FIXED-HEIGHT PEDESTAL	13"	E-COAT	6 RETAIL	B
B	1561107	ECONOMY ADJUSTABLE PEDESTAL	12" to 18"	E-COAT	6 RETAIL	B

Retail packed in box with 4-color label

Rugged all-steel constructed 7" x 7" square base and seat mount, e-coated to resist corrosion. Great for all weather conditions. For use with standard boat seats.

- Adjusts from 12" to 18" in 2" increments (#1561107)

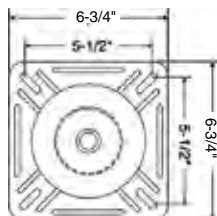

BELLE ADJUSTABLE PEDESTAL



RETAIL IMAGE	PART NUMBER	ADJUSTS	FINISH	PACK QUANTITY	ABYC
A	1440248	13" TO 17"	POWDER COAT	1 RETAIL	B

Retail packed in box with 4-color label

Adjustable post with 10" round base and Trac-Lock™ seat mount. Powder-coat finish to resist corrosion.

- Rotates 360°
- Easy to grip handles
- Fits standard boats
- Universal seat mount pattern: 5" x 5"
- Patent #5,758,856



SEAT STANDS

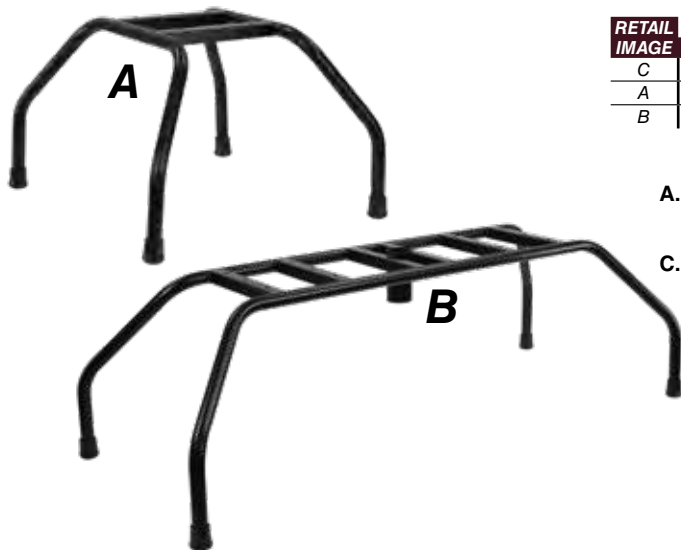

RETAIL IMAGE	PART NUMBER	DESCRIPTION	PACK QUANTITY	ABYC
C	1080050	PORTABLE DECK STAND, SS W/POLY	1 RETAIL	B
A	1080055	SINGLE STAND, BLACK POWDER-COAT	1 RETAIL	B
B	1080056	DOUBLE STAND, BLACK POWDER-COAT	1 RETAIL	B

A. (single seat stand) and B. (double seat stand)
• Adaptor support fits 1.75" post (B.)

C. (portable poly stand)
• Poly base with stainless steel legs





- TABLE TOPS
- POSTS
- MOUNTS
- BASES
- PACKAGES

Tables

SPRINGFIELD Marine's tables enhance your on-the-water experience, providing convenience and comfort while onboard. Designed for easy setup during mealtime or snack time, these tables allow you to extend your boating pleasure without needing to go ashore. They are also perfect for setting up games and other activities.

Our tables come in a wide range of styles to suit your needs. For added convenience, all tables are removable for easy storage, keeping your lounging area spacious and free for other activities when the tables are not in use.

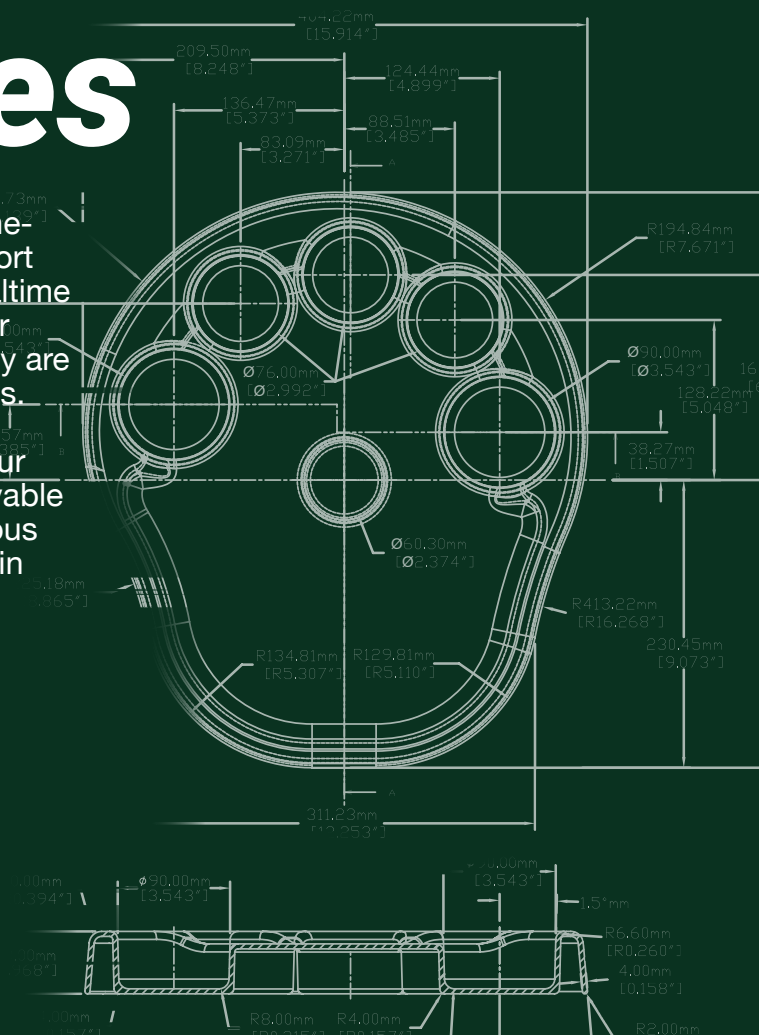
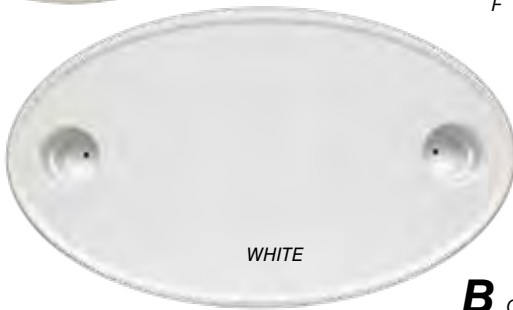

TABLE TOP



A Round
24" Diameter

RETAIL IMAGE	PART NUMBER	TABLE TOP	UMBRELLA SOCKET	COLOR	PACK QUANTITY
A	1670002	ROUND	NO	WHITE	1 RETAIL
A	1670002-U	ROUND	YES	WHITE	1 RETAIL
A	1670002-T	ROUND	NO	TAN	1 RETAIL
B	1670006	OVAL	NO	WHITE	1 RETAIL
B	1670006-U	OVAL	YES	WHITE	1 RETAIL
C	1670008	RECTANGULAR	NO	WHITE	1 RETAIL
D	1670009	PARTY PLATTER	NO	WHITE	1 RETAIL



WHITE



GRAY



TAN

B Oval 18" x 30"

Lightweight molded heavy-duty marine-grade plastic. Available in 4 shapes and sizes with drink holders, with or without umbrella socket.



C Rectangular 16" x 28"



D Party Platter



E Table Loom



F Socket Cover

PARTY PLATTER PACKAGE

RETAIL IMAGE	PART NUMBER	TABLE TOP	UMBRELLA SOCKET	PACK QUANTITY
A	1690901	PARTY PLATTER	NO	1 RETAIL

Retail packed in box with 4-color label



STOWS EASILY TO FIT IN MOST COMPARTMENTS!



PACKAGE INCLUDES:

- Party platter table top, 5 cup holders
- Plastic table mount built into table top
- 2-Piece anodized aluminum locking Thread-Lock™ post
- Thread-Lock™ black plastic surface mount base

THREAD-LOCK™ TABLE PACKAGE

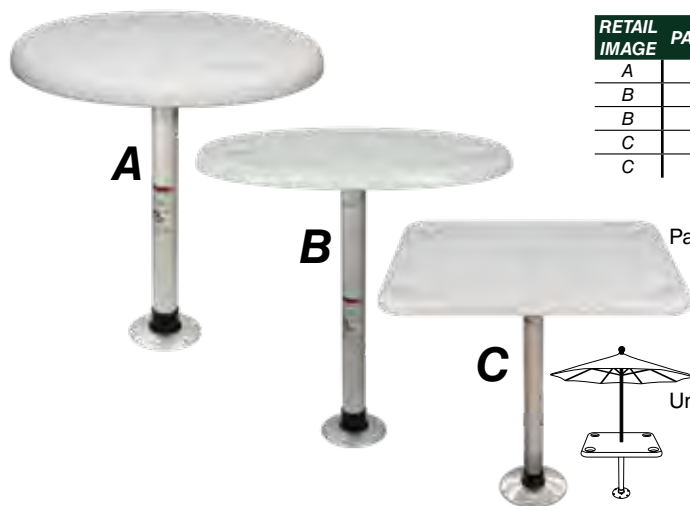

RETAIL IMAGE	PART NUMBER	TABLE TOP	TABLE SIZE	UMBRELLA SOCKET	COLOR	PACK QUANTITY
A	1690102	ROUND	24"	NO	WHITE	1 RETAIL
B	1690106	OVAL	18" x 30"	NO	WHITE	1 RETAIL
B	1690106-U	OVAL	18" x 30"	YES	WHITE	1 RETAIL
C	1690107	RECTANGLE	16" x 28"	NO	WHITE	1 RETAIL
C	1690107-U	RECTANGLE	16" x 28"	YES	WHITE	1 RETAIL

Retail packed in box with 4-color label

Package includes the following parts:

- Table top, available as round, oval, or rectangular
- 27" Thread-Lock™ table post (#3691027-L)
- Table base (#3690001-SL)
- Table mount (#3660704-L)
- Surface mount

Umbrella package includes:

- Heavy thick wall post
- Umbrella socket and cover (1690106-U and 1690107-U only)
- Umbrella retention thumb screw

STOWABLE TABLE PACKAGE



RETAIL IMAGE	PART NUMBER	TABLE TOP	TABLE SIZE	COLOR	PACK QUANTITY
A	1690202	ROUND	24"	WHITE	1 RETAIL
B	1690206	OVAL	18" x 30"	WHITE	1 RETAIL
C	1690207	RECTANGLE	16" x 28"	WHITE	1 RETAIL

Retail packed in box with 4-color label

Package includes the following parts:

- Table top, available as round, oval, or rectangular
- Table post (#3660527)
- Table base (#3660018)
- Table mount (#3660017)
- Recess mount

SIDE MOUNT TABLE PEDESTAL



E Stainless Steel Table Mount

A Stainless Steel Side Table Post

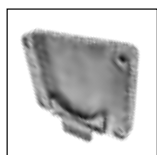

C Polished Side Table Mount Receiver



B Anodized Aluminum Side Table Post 2-3/8"

D 2-3/8" Table Mount

Table mount, table post and receiver sold separately.

OEM IMAGE	PART NUMBER	DESCRIPTION	FINISH	PACK QUANTITY
A	3670702	SS SIDE TABLE POST - POST ONLY	POLISHED	10 BULK
B	3670703	SIDE TABLE POST 2-3/8" - POST ONLY	ANODIZED	10 BULK
C	3760710-P	SIDE TABLE MOUNT RECEIVER, SS	POLISHED	10 BULK
D	3660018	TABLE MOUNT 2-3/8"	ANODIZED	10 BULK
E	3670720	STAINLESS STEEL TABLE MOUNT	POLISHED	10 BULK

3-STAGE TABLE PEDESTAL



IMAGE	PART NUMBER	ADJUSTS	FINISH	PACK QUANTITY
A	1660230	12-3/4" to 28"	ANODIZED	1 BULK
B	1660230-BLK	12-3/4" to 28"	BLACK ANODIZED	1 BULK
A	1660231	14" to 28"	ANODIZED	1 BULK
C	1660232	14" to 28"	BRITE DIP	1 BULK
D	1660232-02	15-1/2" to 28"	BRITE DIP	1 BULK
C	1660236	15" to 30"	BRITE DIP	1 BULK
-	2100102	-	BLACK PLASTIC	1 BULK

Retail packed in box with 4-color label

Gas-powdered pedestals with 12-1/2" table mount and 12" diameter floor base with 11" bolt pattern for added stability—designed to provide maximum strength and support to your dining experience. High-strength aluminum in a variety of heights and finishes.

- Packages includes: adjustable post, base, and table mount
- Removable with low-profile base (1660232-02 only)
- Brite dip post with stainless steel collar (C. and D. only)



ELECTRIC TABLE PEDESTAL

IMAGE	OEM PART NUMBER	DESCRIPTION	ADJUSTS	FINISH	PACK QUANTITY
A	1660238	ELECTRIC TABLE PEDESTAL, THRU-DECK	FLOOR to 28"	BRITE DIP	1 BULK
B	1660237	ELECTRIC TABLE PED, SURFACE MOUNT	12" to 28"	BRITE DIP	1 BULK

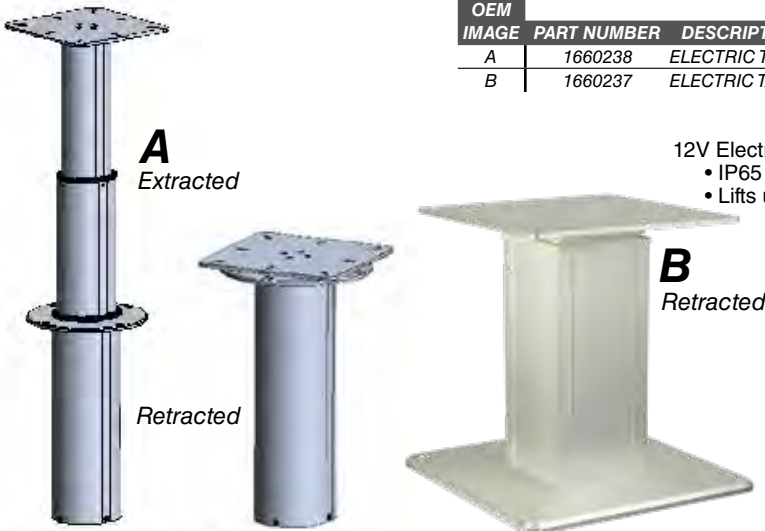

12V Electric actuated table pedestal with brite dip anodized aluminum finish.

- IP65 rated
- Lifts up to 125 lbs

COMING IN 2026!

THREAD-LOCK™ DOUBLE LOCKING POST



RETAIL				
IMAGE	PART NUMBER	FIXED HEIGHT	FINISH	PACK QUANTITY
A	1692027-L1	27"	ANODIZED	6 RETAIL

Retail packed in clamshell with 4-color label

OEM				
IMAGE	PART NUMBER	FIXED HEIGHT	FINISH	PACK QUANTITY
A	3692027-L	27"	ANODIZED	20 BULK
B	3692029-L	29"	ANODIZED	20 BULK

- 2-3/8" double locking post with smooth anodized or fluted brite dip finish.
- Use with any 2-3/8" stowable table mount (sold separately)
 - Use with any Thread-Lock™ table base (sold separately)

THREAD-LOCK™ UNI-LOCK POST



RETAIL				
IMAGE	PART NUMBER	FIXED HEIGHT	FINISH	PACK QUANTITY
A	1690727-SL	27"	SATIN	1 RETAIL

OEM				
IMAGE	PART NUMBER	FIXED-HEIGHT	FINISH	PACK QUANTITY
B	3691014-L	14"	ANODIZED	20 BULK
B	3691025-L	25"	ANODIZED	20 BULK
C	3691027	27"	ANODIZED	20 BULK
B	3691027-L	27"	ANODIZED	20 BULK
B	3691028-L	28"	ANODIZED	20 BULK
D	3692027-LU	27"	ANODIZED	20 BULK

- 2-3/8" Uni-Lock post.
- Use with Uni-Lock table mount (#3660704-L, sold separately)
 - Use with any Thread-Lock™ table base (sold separately)

FOR USE WITH UMBRELLA

2 3/8" DIAMETER POST

BLACK ANODIZED THREAD-LOCK™ POST

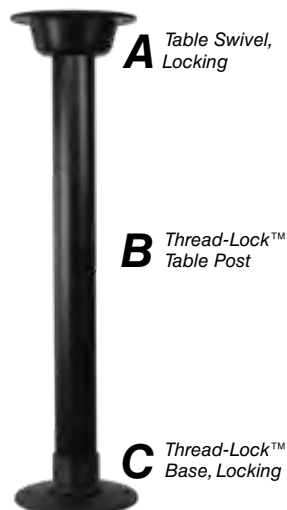

RETAIL				
IMAGE	PART NUMBER	DESCRIPTION	FINISH	PACK QUANTITY
A	3690018-BLK	TABLE SWIVEL, LOCKING	BLACK ANODIZED	20 BULK
B	3692027-LB	THREAD-LOCK™ POST 27", DOUBLE ALUM	BLACK ANODIZED	20 BULK
F	3690001-ALB	THREAD-LOCK™ BASE, LOCKING	BLACK ANODIZED	20 BULK

- Black anodized Thread-Lock™ parts
- Locking groove table mount works with any tapered 2-3/8" Thread-Lock™ post or any 2-3/8" stowable table post (sold separately)
 - 2-3/8" Double locking post works with any 2-3/8" stowable table mount (sold separately) or any Thread-Lock™ table base (sold separately)
 - 2-3/8" Threaded table base is made of high-strength aluminum. Base works with any 2-3/8" Thread-Lock™ table post (sold separately)

THREAD-LOCK™ ADJUSTABLE PEDESTAL



A

2 3/8"
DIAMETER
POST

RETAIL				
IMAGE	PART NUMBER	ADJUSTS	FINISH	PACK QUANTITY
A	3692700	21-1/2" to 27-1/2"	POLISHED	1 RETAIL

Retail packed in clamshell with 4-color label

2-3/8" Stainless steel polished post adjust from 21-1/2" to 27-1/2"

- Use with any 2-3/8" stowable table mount (sold separately)
- Use with any Thread-Lock™ table base (sold separately)

THREAD-LOCK™ TABLE BASE



A

Anodized



B

Satin



C

Black Krinkle

RETAIL				
IMAGE	PART NUMBER	LOCKING	FINISH	PACK QUANTITY
A	1690001-AL1	YES	ANODIZED	6 RETAIL
A	1690001-SL	YES	SATIN	6 RETAIL

Retail packed with 4-color label

OEM				
IMAGE	PART NUMBER	LOCKING	FINISH	PACK QUANTITY
A	3690001-AL	YES	ANODIZED	20 BULK
B	3690001-SL	YES	SATIN	20 BULK
C	3690001-BLKL	YES	BLACK KRINKLE	20 BULK

High-strength 2-3/8" threaded aluminum table base. Available in anodized, satin, or black krinkle finish. 7" diameter with 5-3/4" hole pattern. Total height: .625".

- Use with any 2-3/8" Thread-Lock™ table post (sold separately)

LOW-PROFILE TABLE POST PACKAGE



2 3/8"
DIAMETER
POST



RETAIL				
IMAGE	PART NUMBER	DESCRIPTION	FINISH	PACK QUANTITY
A	1695827-A	LOW-PROFILE POST PACKAGE	ANODIZED	1 BULK

Retail packed in box with 4-color label

Threaded 27" x 2-7/8" anodized aluminum post with low-profile 4" round stainless steel polished passivated base.

- 3/4" - 10 threaded
- Minimum under deck of 3/4"
- Use with 2-7/8" Trac-Lock™ table mount

PACKAGE INCLUDES:

- Threaded 27" Table Post, 3691427-A
- Plug available, sold separately 3760215-SS
- Low-profile pedestal 4" threaded base, 3690020-P



Plug 3760215-SS

30" STOWABLE PEDESTAL PACKAGE

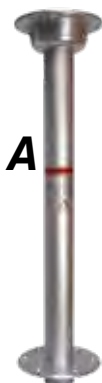

A

2 3/8"
DIAMETER
POST

RETAIL					
IMAGE	PART NUMBER	DIAMETER	FINISH	LOCKING	PACK QUANTITY
A	1660029	2-3/8"	ANODIZED	NON-LOCKING	1 RETAIL

Stowable pedestal package includes:

- 2-3/8" diameter aluminum 30" non-locking post
- High-strength aluminum table mount, 3660018
- 7" aluminum surface mount floor base with a 5-3/4" hole pattern, 3660017
- Requires a 3-1/2" hole in deck

ECONOMY STOWABLE TABLE MOUNT



A

Kennedy Gray



B

Silver Metallic

RETAIL				
IMAGE	PART NUMBER	FINISH	DIAMETER	PACK QUANTITY
A	1660004	KENNEDY GRAY	2-3/8"	1 RETAIL

Retail packed in box with 4-color label

OEM				
IMAGE	PART NUMBER	FINISH	DIAMETER	PACK QUANTITY
A	3660004	KENNEDY GRAY	2-3/8"	20 BULK
B	3660004-SM	SILVER METALLIC	2-3/8"	20 BULK

Non-locking 2-3/8" table mount of high-strength die-cast aluminum comes in two finishes: Kennedy Gray or Silver Metallic.

- 6.22" Diameter with 5" hole pattern
- Works with any 2-3/8" tapered stowable table post (sold separately)
- Mount has offset taper 2-3/8" to 2-1/4"

ECONOMY STOWABLE TABLE POST



A



B

2 3/8"
DIAMETER
POST

OEM				
IMAGE	PART NUMBER	FIXED-HEIGHT	LOCKING	PACK QUANTITY
A	3660324	24"	NON-LOCKING	20 BULK
A	3660325	25"	NON-LOCKING	20 BULK
B	3660525	25"	YES	20 BULK
A	3660327	27"	NON-LOCKING	20 BULK
B	3660527	27"	YES	20 BULK
A	3660328	28"	NON-LOCKING	20 BULK
A	3660334	34"	NON-LOCKING	20 BULK

2-3/8" Aluminum post in anodized finish comes in a variety of heights, locking or non-locking.

- Use with any 2-3/8" stowable table mount (sold separately)
- Use with any 2-3/8" stowable table base (sold separately)
- Thin wall extrusion makes this perfect for lightweight applications
- Posts are tapered from 2-3/8" to 2-1/4"

ECONOMY STOWABLE TABLE BASE



A

RETAIL				
IMAGE	PART NUMBER	FINISH	LOCKING	PACK QUANTITY
A	1660003	KENNEDY GRAY	NON-LOCKING	1 RETAIL

Retail packed in box with 4-color label

OEM				
IMAGE	PART NUMBER	FINISH	LOCKING	PACK QUANTITY
A	3660003	KENNEDY GRAY	NON-LOCKING	20 BULK

7" High-strength aluminum with 5-3/4" hole mounting pattern.

- Use with any 2-3/8" tapered stowable table post (sold separately)
- Requires a 3.5" hole in deck

STOWABLE TABLE MOUNT



RETAIL				
IMAGE	PART NUMBER	FINISH	DIAMETER	PACK QUANTITY
A	1660018-1	ANODIZED	2-3/8"	1 RETAIL

Retail packed in clamshell with 4-color label

OEM				
IMAGE	PART NUMBER	FINISH	DIAMETER	PACK QUANTITY
A	3660018	ANODIZED	2-3/8"	20 BULK
B	3660023	POLISHED	2-3/8"	20 BULK

Locking 2-3/8" groove table mount of high-strength permanent mold aluminum comes in two finishes: Anodized or Polished.

- 7" Diameter with 5-3/4" hole mounting pattern
- Works with any 2-3/8" Thread-Lock™ post or any 2-3/8" tapered stowable table post (sold separately)

STOWABLE TABLE POST



RETAIL				
IMAGE	PART NUMBER	FIXED-HEIGHT	FINISH	PACK QUANTITY
A	1660032-A	27"	ANODIZED	6 RETAIL
A	1660030-A	28"	ANODIZED	6 RETAIL

Retail packed in box with 4-color label

OEM				
IMAGE	PART NUMBER	FIXED-HEIGHT	FINISH	PACK QUANTITY
A	3660026-A	25"	ANODIZED	20 BULK
B	3660026-P	25"	POLISHED	20 BULK
A	3660032-A	27"	ANODIZED	20 BULK
B	3660032-P	27"	POLISHED	20 BULK
A	3660030-A	28"	ANODIZED	20 BULK
A	3660037-A	29"	ANODIZED	20 BULK
A	3660024-A	30"	ANODIZED	20 BULK

2-3/8" post in anodized or polished finish comes in a variety of heights.

- Use with any 2-3/8" stowable table mount (sold separately)
- Use with any 2-3/8" stowable or tapered table base (sold separately)
- Thick wall extrusion

STOWABLE TABLE BASE

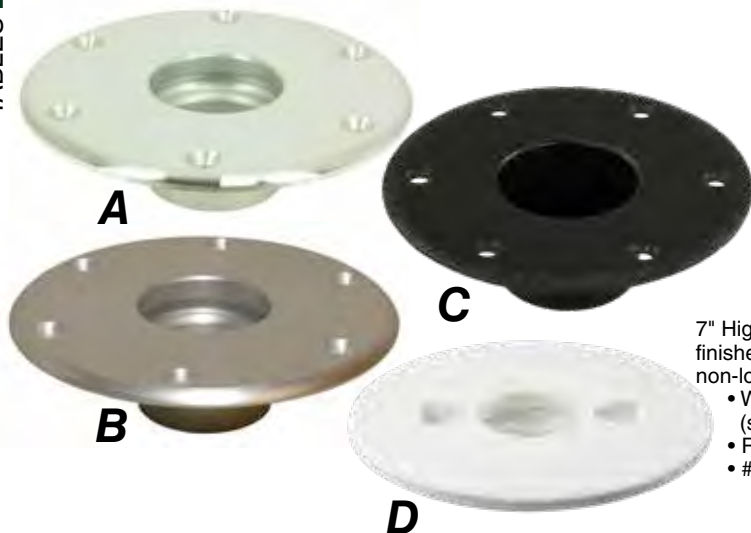

RETAIL				
IMAGE	PART NUMBER	FINISH	LOCKING	PACK QUANTITY
A	1660001	POLISHED	YES	1 RETAIL
B	1660017	ANODIZED	YES	1 RETAIL

Retail packed in box with 4-color label

OEM				
IMAGE	PART NUMBER	FINISH	LOCKING	PACK QUANTITY
A	3660002	POLISHED	YES	20 BULK
B	3660017	ANODIZED	YES	20 BULK
C	3660017-BLK	BLACK KRINKLE	NON-LOCKING	20 BULK
D	3660619	ICE WHITE	NON-LOCKING	20 BULK

7" High-strength aluminum with 5-3/4" hole mounting pattern. Available in four finishes: Anodized, Polished, Kennedy Gray or Ice White, and as locking or non-locking.

- Works with any 2-3/8" stowable or tapered table post (sold separately)
- Requires a 3.5" hole in deck
- #3660619 Inspection plate with molded table mount

29" UNI-LOCK PEDESTAL PACKAGE



A
Locking
Post

B
Non-Locking
Post

RETAIL			
IMAGE	PART NUMBER	DESCRIPTION	PACK QUANTITY
A	1660701	LOCKING UNI-LOCK PEDESTAL PACKAGE	1 RETAIL
B	1660702	NON-LOCKING UNI-LOCK PEDESTAL PACKAGE	1 RETAIL

Retail packed in box with label

7" Floor base with 5-3/4" mounting hole pattern. Requires a 3-1/2" hole in deck.

(A) PACKAGE INCLUDES:

- 2-3/8" Diameter locking anodized aluminum post (#3660727-L)
- High-strength black plastic table mount (#3660704-L) and floor base (#3660703)

(B) PACKAGE INCLUDES:

- 2-3/8" Diameter non-locking anodized aluminum post (#3660727)
- High-strength black plastic table mount (#3660704-L) and floor base (#3660703)

UNI-LOCK TABLE MOUNT / BASE



A

B

RETAIL			
IMAGE	PART NUMBER	DESCRIPTION	PACK QUANTITY
A	1660704-L	BLACK COMPOSITE UNI-LOCK TABLE MOUNT	1 RETAIL
B	1660703	BLACK COMPOSITE UNI-LOCK TABLE BASE	1 RETAIL

Retail packed in box with 4-color label

OEM			
IMAGE	PART NUMBER	DESCRIPTION	PACK QUANTITY
A	3660704-L	BLACK COMPOSITE UNI-LOCK TABLE MOUNT	20 BULK
B	3660703	BLACK COMPOSITE UNI-LOCK TABLE BASE	20 BULK

High-strength black plastic composite table mount / base. 7" diameter with 5-3/4" hole pattern.

- Use with any 2-3/8" Uni-Lock table post (sold separately)

UNI-LOCK TABLE POST

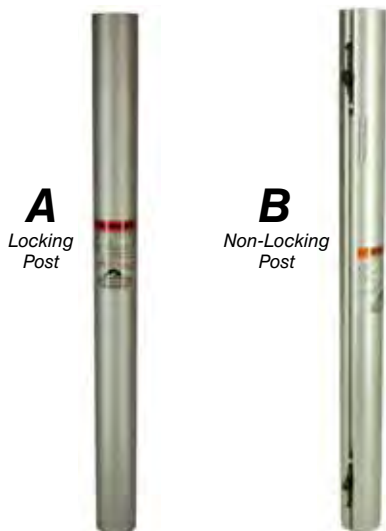

A
Locking
Post

B
Non-Locking
Post

OEM				
IMAGE	PART NUMBER	FIXED-HEIGHT	LOCKING	PACK QUANTITY
A	3660727	27"	NON-LOCKING	20 BULK
B	3660727-L	27"	YES	20 BULK

2-3/8" post with anodized finish. Available in locking or non-locking.

- Use with 2-3/8" Uni-Lock table mount (#3660704-L, sold separately)
- Use with 2-3/8" Uni-Lock table base (#3660703, sold separately)

2 3/8"
DIAMETER
POST

2-7/8" TABLE PACKAGE

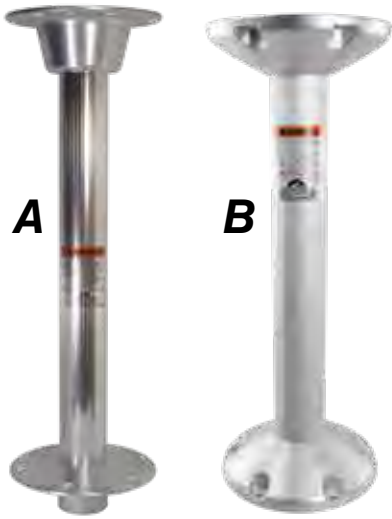

RETAIL			
IMAGE	PART NUMBER	DESCRIPTION	PACK QUANTITY
A	1661127-CAL	2-7/8" TABLE PACKAGE - ANODIZED FLUTED	1 RETAIL

Retail packed in box with 4-color label

OEM			
IMAGE	PART NUMBER	DESCRIPTION	PACK QUANTITY
B	1661624	2-7/8" SURFACE MOUNT PACKAGE 24" - ANODIZED	1 BULK
-	1661624-P	2-7/8" SURFACE MOUNT PACKAGE 24" - POLISHED	1 BULK

All packages come with 9" floor base with 8" mounting hole pattern and requires a 3-1/2" hole in deck.

(A) PACKAGE INCLUDES:

- 2-7/8" diameter aluminum post - anodized fluted
- High-strength anodized aluminum table mount
- Anodized aluminum thru-deck floor base

2-7/8" STOWABLE TABLE MOUNT



OEM			
IMAGE	PART NUMBER	DESCRIPTION	PACK QUANTITY
A	3660207	2-7/8" STOWABLE TABLE MOUNT - ANODIZED	20 BULK
B	3100021-1	2-7/8" NON-LOCKING SWIVEL	20 BULK
C	3660107	2-7/8" STOWABLE TABLE BASE - ANODIZED	20 BULK

2-7/8" High-strength anodized aluminum table mount / base. 9" diameter with 8" mounting hole pattern.

- Use with any 2-7/8" stowable table post (sold separately)
- Use with #3100021-1 with #3664274-RV

2-7/8" STOWABLE TABLE POST

TABLES



OEM					
IMAGE	PART NUMBER	FIXED-HEIGHT	ADJUSTABLE	FINISH	PACK QUANTITY
A	3664230-RV	23"	-	POLISHED	10 BULK
A	3664250-RV	25"	-	POLISHED	10 BULK
B	3660127-CAL	27"	-	ANODIZED	20 BULK
C	3660127-CPL	27"	-	POLISHED	20 BULK
A	3664275-RV	27-1/2"	-	POLISHED	10 BULK
A	3664300-RV	29-1/2"	-	POLISHED	10 BULK
D	3660619	-	16" to 27"	ANODIZED	1 BULK

2 7/8"
DIAMETER
POST

2-7/8" High-strength aluminum post with fluted anodized or polished finish, available in a variety of heights.

- (A) Use with any 2-3/8" Trac-Lock™ swivel and 2-7/8" non-tapered stowable base mount (sold separately)
- (B and C) Use with 2-7/8" tapered to 2-11/16" stowable table mount and base (sold separately)
- (D) Stowable 2-7/8" tapered gas-cylinder table pedestal with anodized finish. Adjusts 16" to 27"

27" BOLT-LOCK PEDESTAL PACKAGE

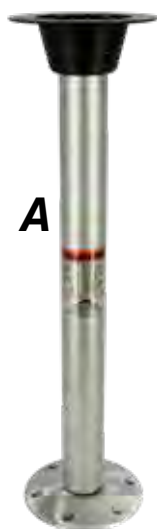

2 3/8" DIAMETER POST



RETAIL

IMAGE	PART NUMBER	DESCRIPTION	PACK QUANTITY
A	1662127	BOLT-LOCK PEDESTAL PACKAGE, 27"	1 RETAIL

Retail packed in box with label

7" Round surface mount floor base with 5-3/4" mounting hole pattern.

PACKAGE INCLUDES:

- 2-3/8" High-strength anodized aluminum post (#3662027)
- High-strength black plastic table mount (#3660704-L)
- Aluminum satin finish floor base (#3690007)

Attach post to base and twist for a secure, locking fit.

BOLT-LOCK MOUNT / BASE



2 3/8" DIAMETER POST

OEM IMAGE	PART NUMBER	FIXED-HEIGHT / DIAMETER	FINISH	PACK QUANTITY
A	3662027	27"	ANODIZED	20 BULK
B	3663027	27"	ANODIZED	20 BULK
A	3662030	30"	ANODIZED	20 BULK
A	3662031	31"	ANODIZED	20 BULK
B	3663030	31"	ANODIZED	20 BULK
C	3690007	2-3/8"	SATIN	20 BULK
D	3690007-A	2-3/8"	ANODIZED	20 BULK
E	3690007-P	2-3/8"	POLISHED	20 BULK

(A and B) 2-3/8" high-strength aluminum post with anodized finish.

- Use with any 2-3/8" Uni-Lock table mount (sold separately)
- Use with any Bolt-Lock base (C, D, E, sold separately)

(B) 3663030 tapered post, use with #3663027 (2-3/8") tapered table mount

(C, D, E) 7" round base with 5-3/4" hole pattern. Available in Satin, Anodized, or Polished finish.

- Attach post to base and twist for a secure, locking fit.

TABLE ACCESSORIES



Conveniently stow your 2-3/8" table pedestals when not in use. Retail sold in pairs. OEM sold in single, OEM.

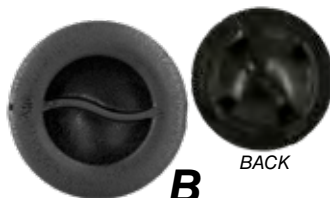

Plastic Thread-Lock™ cover keeps sockets clear when not in use.

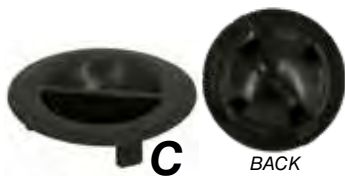

Plastic stowable cover keeps sockets clear when not in use.



Umbrella Socket Cover - Black (available in white #7100170-W)

RETAIL

IMAGE	PART NUMBER	DESCRIPTION	PACK QUANTITY
A	2100025	STOWABLE POST CLIPS, SOLD IN PAIRS	10 RETAIL
B	2100092	THREAD-LOCK™ BASE SOCKET COVER	6 RETAIL
C	2100093	STOWABLE BASE SOCKET COVER	6 RETAIL
D	7100170	UMBRELLA SOCKET COVER	1 RETAIL

Retail packed in clamshell with 4-color label

OEM

IMAGE	PART NUMBER	DESCRIPTION	PACK QUANTITY
A	2100104	STOWABLE POST CLIPS, SOLD SINGLE	100 BULK
B	2100092-B	THREAD-LOCK™ BASE SOCKET COVER	20 BULK
C	2100093-B	STOWABLE BASE SOCKET COVER	20 BULK
E	2100115	BASE LATCH KIT	6 BULK



Replacement latch kit for Thread-Lock™ table bases

- **INBOARD**
- **OUTBOARD**
- **POP-UP**
- **RECEIVERS**
- **BASES**

Ski Tows

SPRINGFIELD Marine's ski tow pylons are engineered to provide unparalleled structural integrity, ensuring a safe and enjoyable experience for water sports enthusiasts. These pylons are constructed from high-strength aircraft aluminum, guaranteeing long-lasting durability even in harsh marine environments. The robust design minimizes flex and wobble, offering a stable platform for towing skiers, wakeboarders, and other towable devices. Each pylon undergoes rigorous testing to meet and exceed ABYC and industry standards, providing peace of mind that they will perform reliably under demanding conditions.

In addition to their strength, **SPRINGFIELD Marine's** ski tow pylons feature innovative engineering to enhance their functionality and ease of use. The pylons are designed with secure mounting systems that ensure a firm attachment to the boat, preventing any shifting or loosening during use. This secure attachment is crucial for maintaining safety and performance while towing at high speeds. With **SPRINGFIELD Marine's** ski tow pylons, boaters can enjoy the thrill of water sports with the confidence that their equipment is built to last and perform flawlessly.

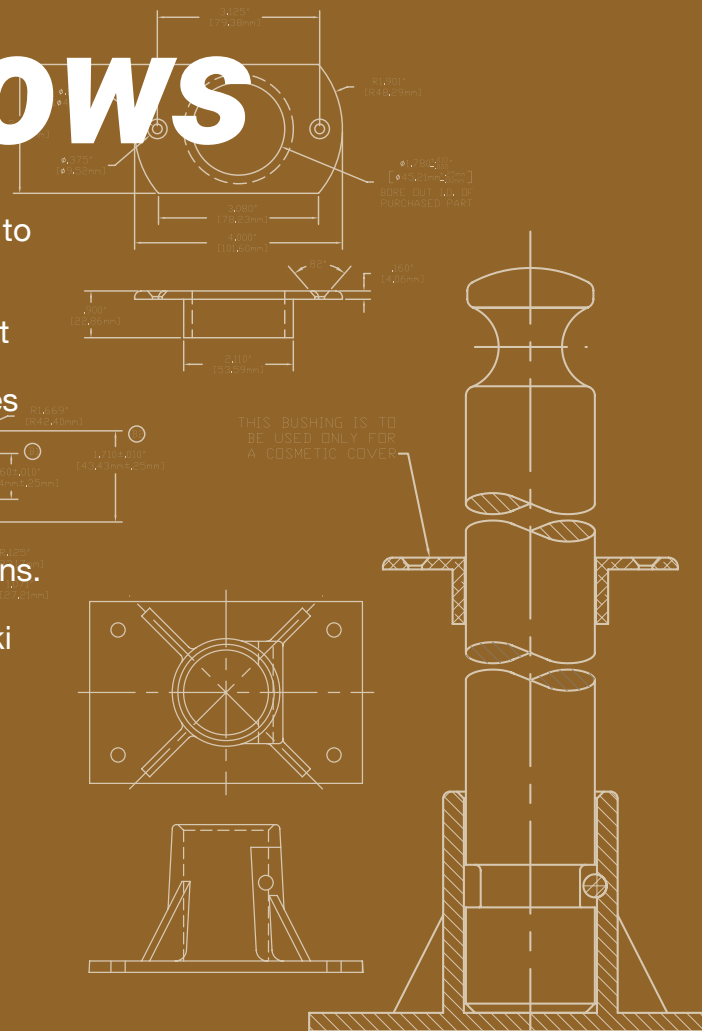

INBOARD POP-UP SKI TOW



A



Stows Flush

OEM IMAGE	PART NUMBER	DESCRIPTION	PACK QUANTITY
A	1800090	POP-UP SKI TOW, INBOARD, ROUND BASE	1 BULK

Made from high-strength aircraft aluminum, this single post design conceals neatly away into the deck when not in use and is activated with a single locking feature for easy conversion into ski ready position. Pops up with just a twist and held in position with a spring.

- 2-1/2" above deck, 5-1/4" below deck
- Anodized finish
- Withstands 2000 lbs static load

OUTBOARD POP-UP SKI TOW

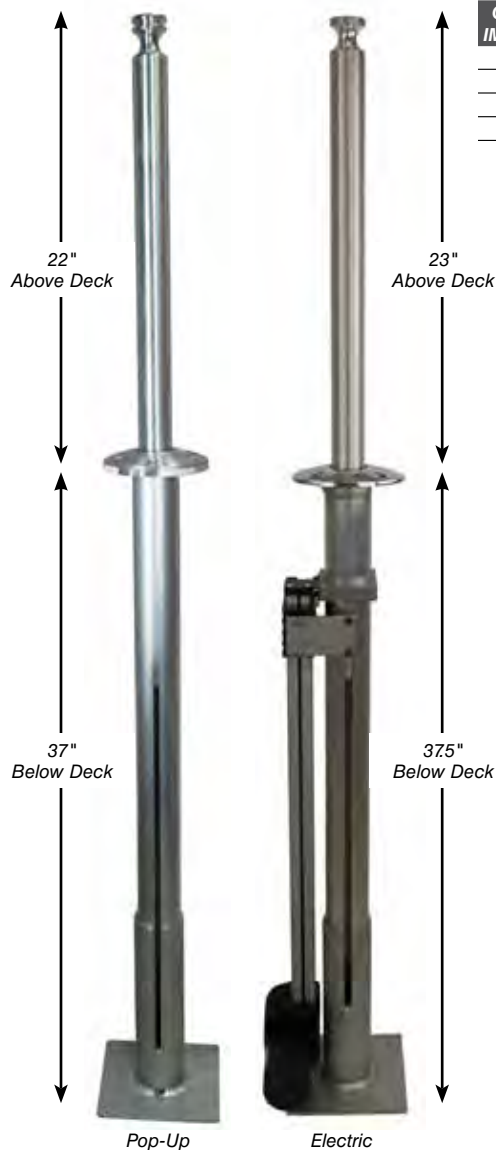

OEM IMAGE	PART NUMBER	DESCRIPTION	ABOVE DECK	BELOW DECK	PACK QUANTITY
A	1800095	POP-UP SKI TOW, OUTBOARD, ROUND BASE	22"	37"	1 BULK
B	1800096	POP-UP SKI TOW, OUTBOARD, OVAL BASE	22"	37"	1 BULK
C	1800096-E	ELECTRIC SKI TOW, OUTBOARD, OVAL BASE	23"	37.5"	1 BULK
B	1800097	POP-UP SKI TOW, OUTBOARD, ROUND BASE	15"	28"	1 BULK
-	1800096-EXSS	POP-UP SKI TOW, OUTBOARD, STAINLESS OVAL BASE	27"	42"	1 BULK

Made from high-strength aircraft aluminum, this single post design conceals neatly away into the deck when not in use.

- Stows flush with deck
- Designed for 1600 lbs static load

(A and B) Pop-up ski tows are activated with a single locking feature for easy conversion into ski ready position. 22" above deck and 37" below deck.

(C) Electric ski tow tracks up and down on a guide rail and raises in under 25 seconds at the press of a switch. 23" above deck and 37.5" below deck. Designed for 1600 lbs of static load.



A

Pop-Up Ski Tow, Round Base



B

Pop-Up Ski Tow, Oval Base



C

Electric Ski Tow, Oval Base



D

Pop-Up Ski Tow, Stainless Oval Base



SKI TOW PYLON

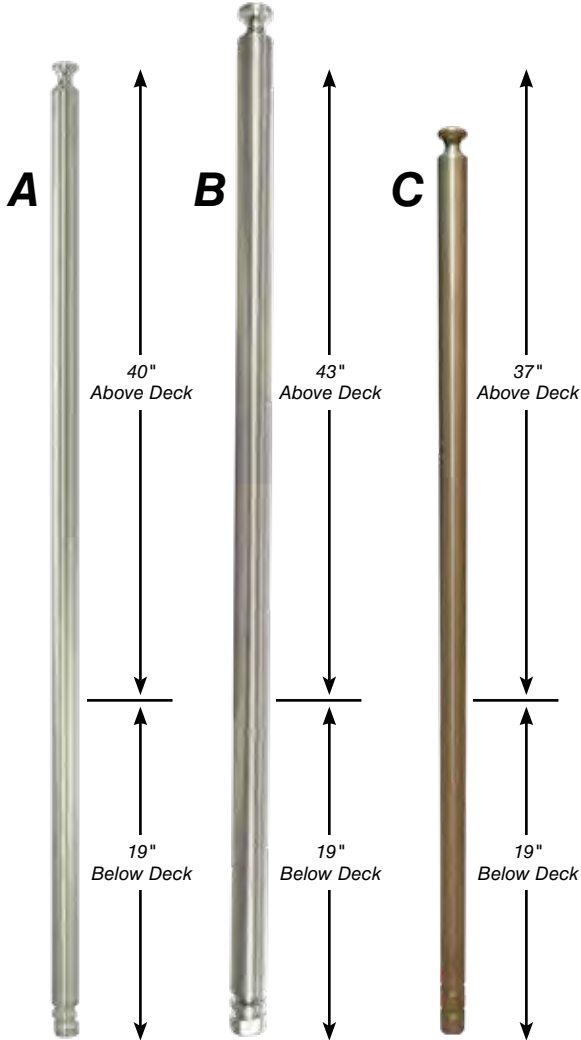

OEM IMAGE	PART NUMBER	DESCRIPTION	TOTAL LENGTH	ABOVE DECK	PACK QUANTITY
A	1800039-T	SKI TOW, TWIST-IN	57.7"	40"	1 BULK
A	1800041-T	SKI-TOW, TWIST-IN	54.7"	37"	1 BULK
B	1800051-T	SKI-TOW, TWIST-IN	49.7"	32"	1 BULK
C	1800061-T	SKI-TOW, TWIST-IN	60.7"	43"	1 BULK
C	1800066-T	SKI-TOW, TWIST-IN	64.7"	36"	1 BULK
C	1800067-T	SKI-TOW, TWIST-IN	66.7"	37"	1 BULK

OEM IMAGE	PART NUMBER	DESCRIPTION	TOTAL LENGTH	ABOVE DECK	PACK QUANTITY
D	1800040-T	LOW-PROFILE, TWIST-IN	38.7"	33.3"	1 BULK
D	1800043-T	LOW-PROFILE, TWIST-IN	45.7"	28"	1 BULK

1-3/4" High-strength aircraft aluminum pylons are available in a variety of lengths.

- Must have a minimum of 19" below deck
- For strength purposes, 43" is the most unsupported distance allowed
- Solid bar aluminum
- Satin finish with anodized coating
- Designed for 1600 lbs static load

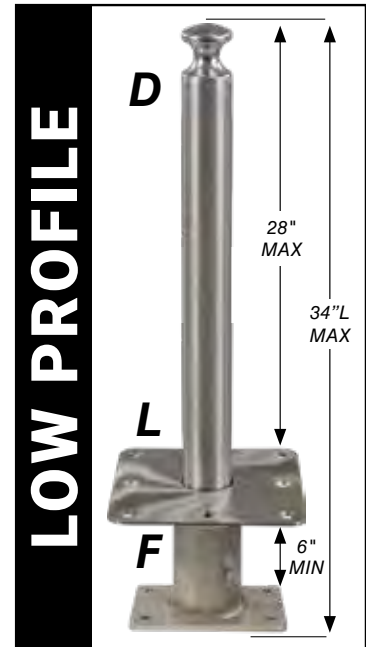
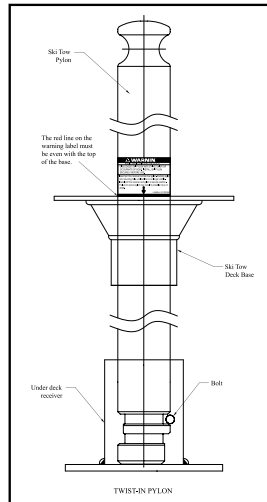

MOUNTING RECEIVER & BASE



OEM IMAGE	PART NUMBER	DESCRIPTION	PACK QUANTITY
J	1640034	4-1/2" x 4-1/2" DECK BASE	1 BULK
L	1640036	7" x 7" SKI TOW DECK BASE	1 BULK
-	1800020	SKI TOW RECEIVER MOUNTING PLATE	30 BULK
E	1800044	SKI TOW RECEIVER	1 BULK
F	1800044-SS	HEAVY-DUTY LOW-PROFILE RECEIVER	1 BULK
G	1800047	BRACKET STRAP FOR POP-UP SKI TOW	1 BULK
H	1800048	MOUNTING PLATE WITH HARDWARE 9.75"	5 BULK
H	1800052	MOUNTING PLATE 5.75"	5 BULK
I	3640032-PP	3-1/2" x 5-1/2" DECK BASE	20 BULK
-	3640033-PP	5.5" ROUND BASE	20 BULK
J	3640034	4-1/2" x 4-1/2" DECK BASE	20 BULK
K	3640035	7" x 7" 2-HOLE SKI TOW/SPRING-LOCK™ DECK BASE, MILL	10 BULK
K	3640035-S	7" x 7" 2-HOLE SKI TOW/SPRING-LOCK™ DECK BASE, SATIN	10 BULK
L	3640036	7" x 7" SKI TOW DECK BASE, SATIN	20 BULK
L	3640036-PP	7" x 7" SKI TOW DECK BASE, POLISHED PASS	20 BULK
L	3640038	8.5" x 8.5" SKI TOW DECK BASE OVERSIZE	20 BULK
M	3640039	5" x 5" 2-HOLE SKI TOW/SPRING-LOCK™ DECK BASE	10 BULK
N	3640040	7" x 7" LOW-PROFILE SKI TOW DECK BASE	20 BULK
O	3640041-PP	3" x 4" DECK BASE	20 BULK
-	3640045-S	7" x 7" 2-HOLE SKI TOW/KINGPIN™ DECK BASE, SATIN	10 BULK
-	3640047-S	7" x 7" SKI TOW/PLUG-IN™ DECK BASE, SATIN	10 BULK
P	3760250	PLUG FOR BASE	10 BULK
I	3640032-PP01	3.5" x 5.5" BASE NOTCHED FOR PLUG	10 BULK

Necessary items for mounting ski tow pylons to your boat.

2" SKI TOW

OEM IMAGE	PART NUMBER	DESCRIPTION	PACK QUANTITY
A	1801051-T	2" LOW-PROFILE SKI TOW PYLON, 51-IN., TWIST-FIN	1 BULK
-	1801057-T	2" SKI TOW PYLON, 57-IN., TWIST-IN	1 BULK
-	1801060-T	2" SKI TOW PYLON, 60-IN., TWIST-IN	1 BULK
B	1801071-02	2" SKI TOW PYLON, 71-IN., TWIST-IN	1 BULK
C	1800096-02	2" POPUP SKI TOW, OUTBOARD, OVAL BASE	1 BULK

Made from high-strength aircraft aluminum, heavy-duty 2" diameter ski tow pylons twist in to lock into receiver. Designed for quick and easy removal, notched in two points allowing drop-in and removal without accessing below deck.

- Base provides maximum durability (sold separately)
- Meets ABYC H-40 (2024) updated standards
- Exceeds pull force of 2000 LBS

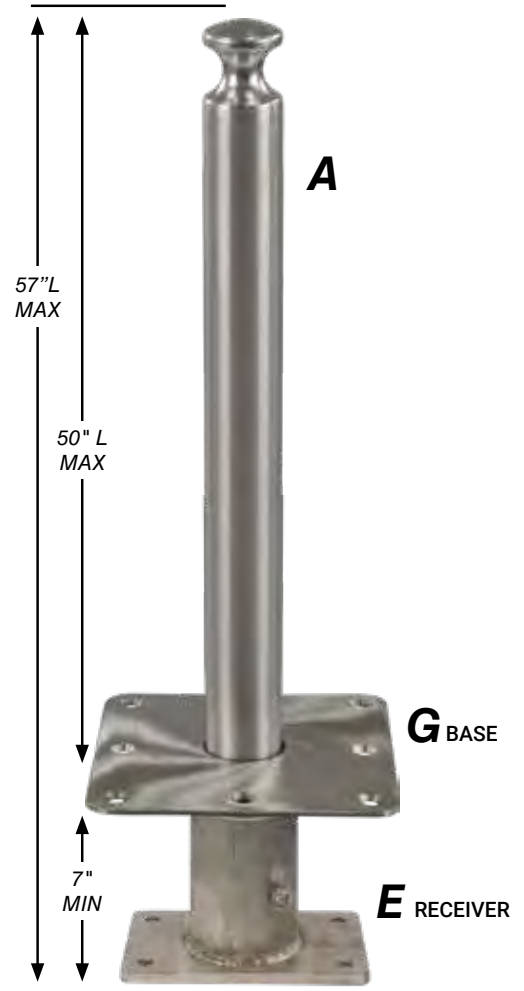
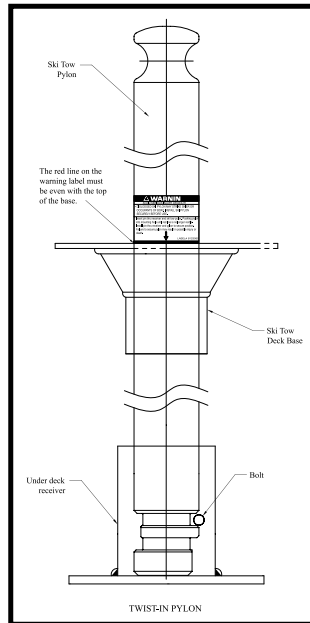
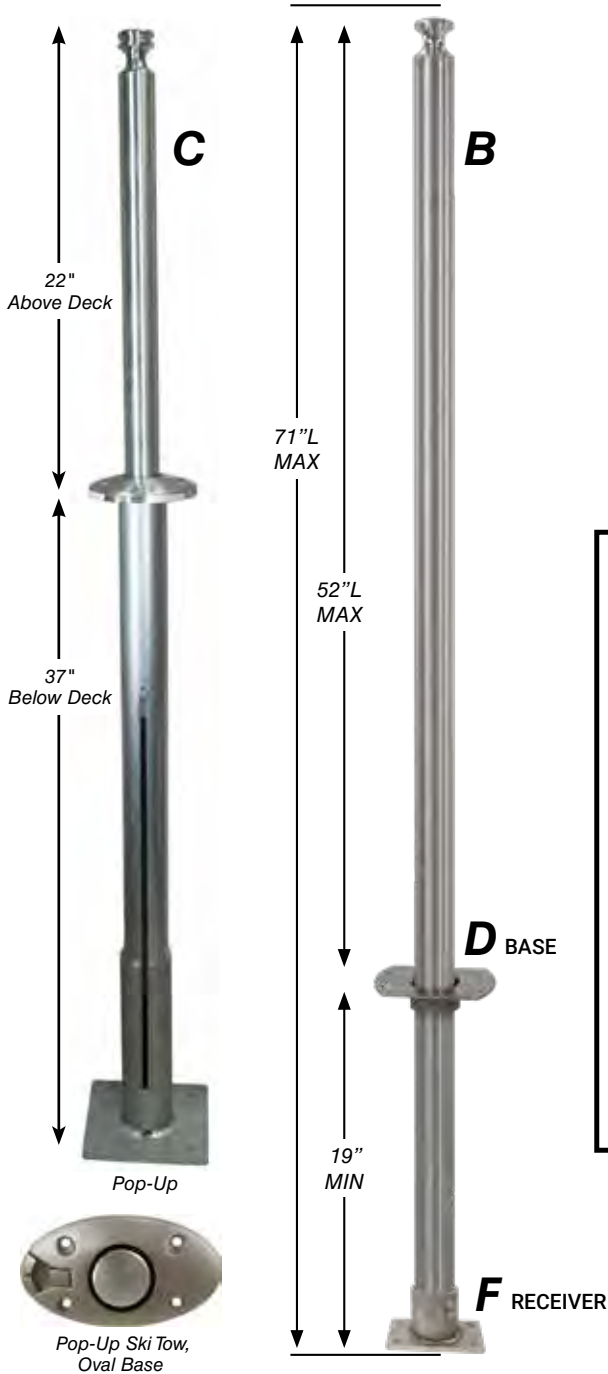

2" SKI TOW SYSTEM

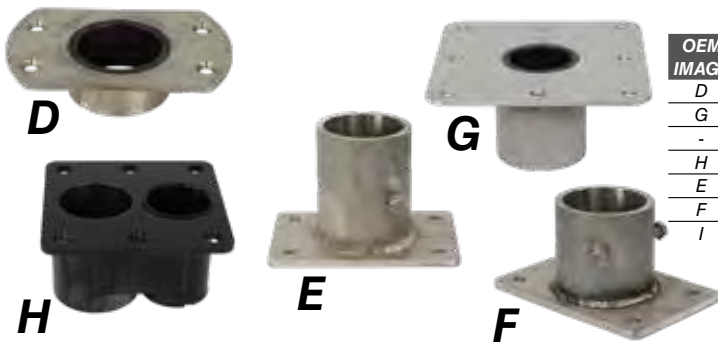

OEM IMAGE	PART NUMBER	DESCRIPTION	PACK QUANTITY
D	3640031-PP02	5.5" x 3.125" FLAT SIDE BASE	1 BULK
G	3640040-02	7" x 7" SKI TOW 2" BASE, SATIN	1 BULK
-	3640040-PP02	7" x 7" SKI TOW 2" BASE, POLISHED PASSIFIED	1 BULK
H	3640039-02	5" x 5" SKI TOW 2" BASE W/SPRING-LOCK™	1 BULK
E	1800044-7SS02	6" X 4" FABRICATED LOW-PROFILE RECEIVER	1 BULK
F	1800044-SS02	6" X 4" FABRICATED RECEIVER	1 BULK
I	3760250-02	PLUG FOR 2" BASE	1 BULK

- DIVE
- BOARDING
- TELESCOPING
- FIXED
- PLATFORM

Ladders

SPRINGFIELD Marine proudly presents our new line of boarding ladders, meticulously designed to offer both durability and versatility. Crafted from either high-strength aluminum or corrosion-resistant stainless steel, these ladders are built to endure the challenging marine environment, ensuring long-lasting reliability. Available in polished or black electroplated finishes, they bring a touch of elegance and modernity to any boat. We offer a range of configurations, including telescopic or fixed step options, with 2 to 5 steps to cater to various boarding needs and preferences.

Our boarding ladders not only provide superior functionality but also adhere to the highest safety standards, meeting the stringent ABYC H-41 guidelines. This compliance guarantees that our ladders are safe, robust, and reliable for all users. **SPRINGFIELD Marine's** new boarding ladders ensure a secure and comfortable experience. With easy installation and exceptional build quality, these ladders are the perfect addition to any vessel, enhancing both convenience and safety for boat owners and their guests.

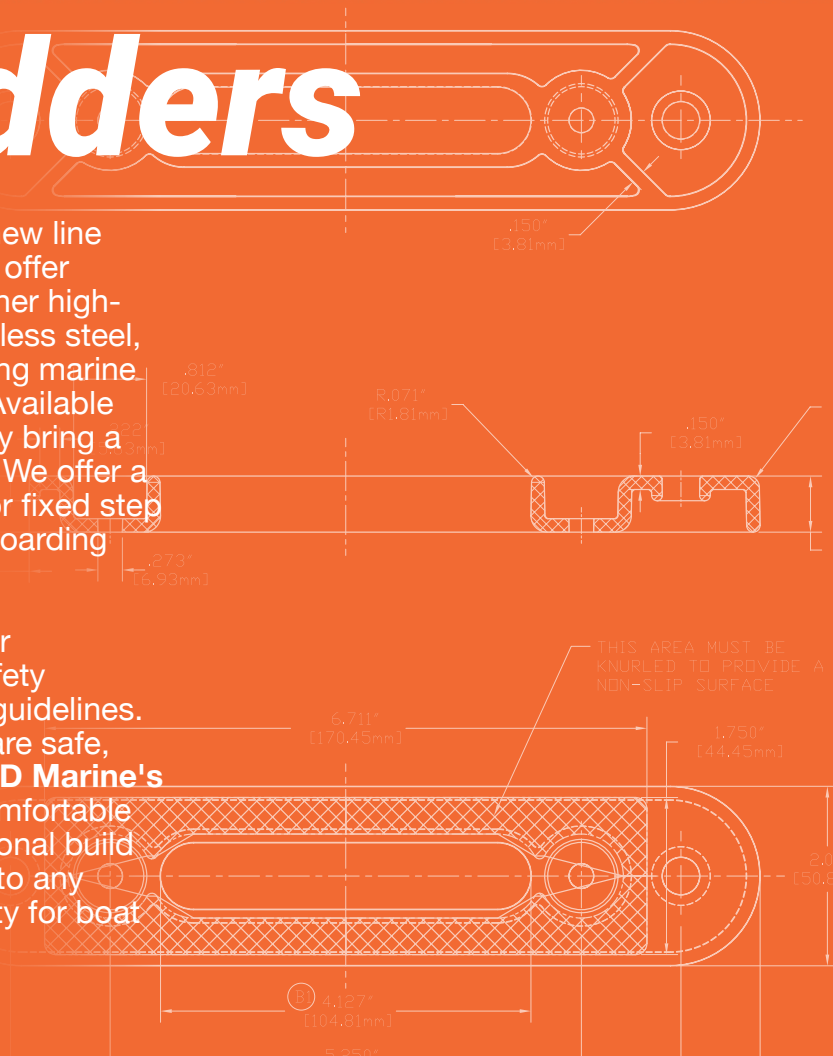

NEW! Stainless Steel and aluminum, telescoping and fixed boarding ladders available in polished or black electroplated finishes.

- Securing strap included on telescoping models
- Flat treads for added comfort
- Corrosion resistant
- Meets ABYC H-41 standards



IMAGE	P/N: SS304	P/N: SS316	DESCRIPTION	PACK QUANTITY
A		1801230-03	LADDER, DIVE, 3STEP	1 PACK
		1801230-04	LADDER, DIVE, 4STEP	1 PACK
B		1800235-04	LADDER, 4STEP	1 PACK
		1800240-02	PLATFORM, O/B, 2STEP	1 PACK
		1800240-03	PLATFORM, O/B, 3STEP	1 PACK
		1800245-03	LADDER, TELESCOPING TRANSOM, 3STEP	1 PACK
		1800250-03	LADDER, TELESCOPING DROP, 3STEP	1 PACK
C		1800250-04	LADDER, TELESCOPING DROP, 4STEP	1 PACK
		1800250-05	LADDER, TELESCOPING DROP, 5STEP	1 PACK
		1801255-03	LADDER, UNDER PLATFORM, 3STEP	1 PACK
D		1801255-04	LADDER, UNDER PLATFORM, 4STEP	1 PACK
		1800260-04	LADDER, FOLDING, BOARDING, 4STEP	1 PACK
E		1800265-04	LDR, REMOVABLE, FOLDING, BOARDING, 4STEP AL	1 PACK
		1801270-03	LADDER, GUNWALE HOOK, 3STEP	1 PACK
F		1801270-04	LADDER, GUNWALE HOOK, 4STEP	1 PACK
G		1801275-04	LADDER, TELESCOPING TRANSOM, 4STEP	1 PACK
		1800280-03	LADDER, TELESCOPING SWIM, 3STEP	1 PACK
H		1801280-04	LADDER, TELESCOPING SWIM, 4STEP	1 PACK



G
TELESCOPIC
4-STEP
STAINLESS STEEL
WITH GRAB RAIL



D
4-STEP
STAINLESS STEEL
UNDER
PLATFORM



A
4-STEP DIVE

E
4-STEP
ALUMINUM
REMOVABLE
FOLDING



C
ELECTROPLATED
FINISH



F
4-STEP
GUNWALE HOOK



H
TELESCOPIC
4-STEP
STAINLESS STEEL



B
2-STEP
PLATFORM

PINCHLESS HINGES

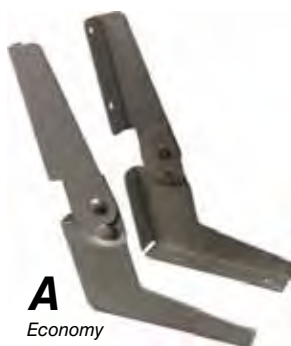

A
Economy

OEM IMAGE	PART NUMBER	DESCRIPTION	FINISH	DEPTH x HEIGHT	ANGLE	PACK QUANTITY
A	1080035	ECONOMY	MILL	6" x 10"	115°	10 BULK
A	1080035-BLK	ECONOMY	BLACK	6" x 10"	115°	10 BULK
B	1080025	SMALL PINCHLESS	MILL	6" x 9.5"	112°	10 BULK
B	1080025-BLK	SMALL PINCHLESS	BLACK	6" x 9.5"	112°	10 BULK
E	1080027	MEDIUM PINCHLESS	MILL	6" x 10.5"	112°	10 BULK
E	1080027-BLK	MEDIUM PINCHLESS	BLACK	6" x 10.5"	112°	10 BULK
C	1080026	LARGE PINCHLESS	MILL	6" x 12.5"	112°	10 BULK
C	1080026-BL	LARGE PINCHLESS	BLACK	6" x 12.5"	112°	10 BULK
D	1080025-SS	STAINLESS STEEL PINCHLESS	POLISHED	6" x 9.5"	118°	10 BULK
C	1080028-BR	LARGE PINCHLESS	BROWN	7.75" x 11.12"	102°	10 BULK
C	1080028-BLK	LARGE PINCHLESS	BLACK	7.75" x 11.12"	102°	10 BULK



B
Small



C
Large

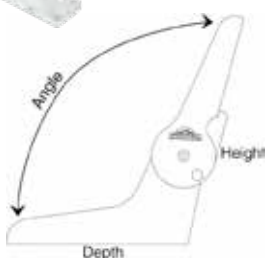

High-strength aluminum. Sold in pairs - left & right.



D
Stainless Steel

E
Medium

HELM ARMREST / SEAT BACK SUPPORT

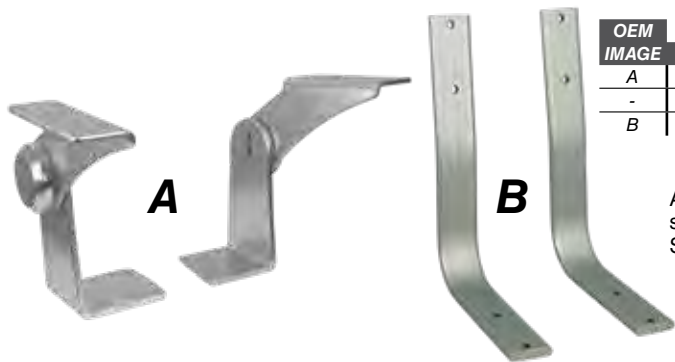

A

B

OEM IMAGE	PART NUMBER	DESCRIPTION	PACK QUANTITY
A	1080005-NC	HELM FLIP-UP ARMREST, NO CUSHION, ANODIZED	1 BULK
-	1080005-NCSS	HELM FLIP-UP ARMREST, NO CUSH STAINLESS STEEL	1 BULK
B	1080010-M	SEAT BACK SUPPORTS, ANODIZED	1 BULK

Armrests flip up while offering a solid feel. Seat back support gives strong stability for long days on the water or while underway.

Sold in pairs - left & right.

- Meets ABYC H-31

ARMREST SUPPORT

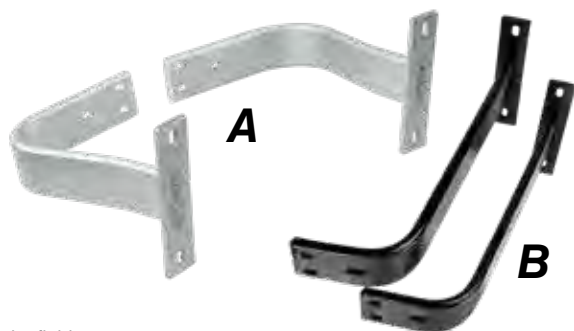

A

B

OEM IMAGE	PART NUMBER	DESCRIPTION	PACK QUANTITY
A	1080009-M	ANODIZED ARMREST SUPPORTS	1 BULK
B	1080016-BL	BLACK ARMREST WITH 101° BEND	1 BULK

Sold in pairs - left & right.

SPRING-LOADED MOUNTING HINGES

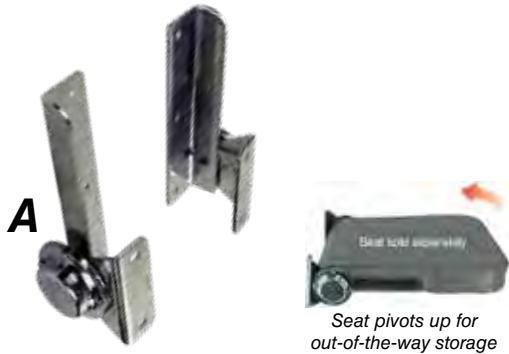

OEM IMAGE	PART NUMBER	DESCRIPTION	FINISH	PACK QUANTITY
A	1080040	SPRING LOADED MOUNTING HINGE	STAINLESS STEEL	1 BULK

This space saving design offers more room on your boat without the sacrifice of comfort or support. Easily mounts to boat for quick installation. 316 polished stainless steel.

- Folds down easily
- Stows in up position
- Sold in pairs - left & right
- Available in 304 stainless steel
- Spring-loaded allows for auto stow



FOLD DOWN MOUNTING HINGE

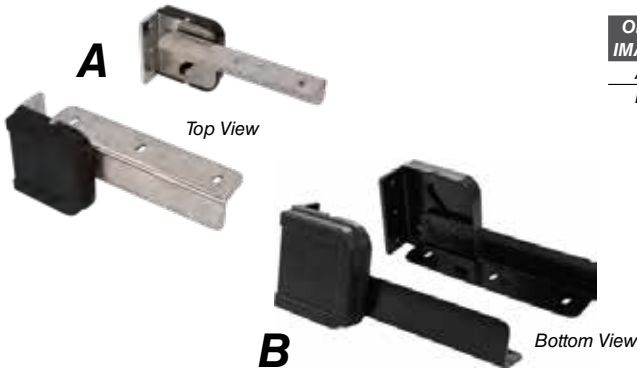

OEM IMAGE	PART NUMBER	DESCRIPTION	FINISH	PACK QUANTITY
A	1080031	FOLD DOWN MOUNTING HINGE, 3°	STAINLESS STEEL	10 BULK
B	1080032	FOLD DOWN MOUNTING HINGE, 0°	MILD / E-COAT	10 BULK

Another space saving design offers room on your boat without the sacrifice of comfort or support. Easily mounts to boat for quick installation.

- Folds down easily for stowage (slight lift with inward push releases hinge)
- Sold in pairs - left & right
- Patent pending



PARALLEL SEAT HINGE



OEM IMAGE	PART NUMBER	DESCRIPTION	HEIGHT	PACK QUANTITY
A	3042045	PARALLEL SEAT HINGE	18.9"	10 BULK
A	3042048	PARALLEL SEAT HINGE	13"	10 BULK
B	3042045-EC	PARALLEL SEAT HINGE - E-COAT	18.9"	10 BULK
C	3042045-SS	PARALLEL SEAT HINGE - STAINLESS STEEL	18.9"	10 BULK

Polished aluminum parallel seat hinges are designed to move the seat's backrest forward and back, and offers secure and stable support in either position.

- Sold in pairs as shown
- 52° angle stowed
- 76° total travel

BOLSTER SEAT HINGE

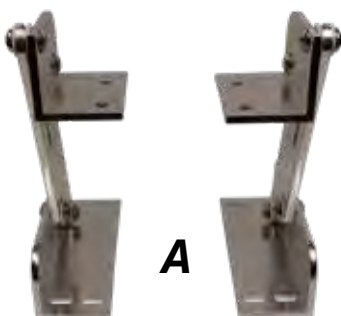

OEM IMAGE	PART NUMBER	DESCRIPTION	PACK QUANTITY
A	1042501-BD1	PARALLEL BOLSTER SEAT HINGE	10 BULK

Bolster seat hinge converts your seat from a sit-down to a stand-up. Quality built brite dip aluminum offers durable long-lasting satisfaction.

- Sold in pairs as shown



1-PIECE ARMREST

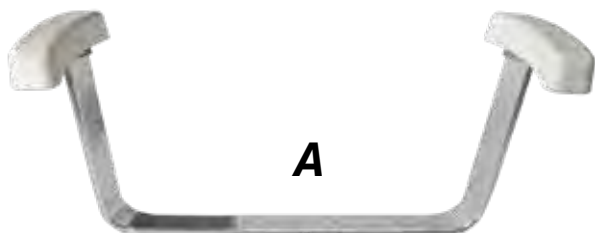

OEM			
IMAGE	PART NUMBER	DESCRIPTION	PACK QUANTITY
A	1080013-G	ONE-PIECE CHAIR ARMREST	1 BULK

Sturdy polished aluminum with plastic armrest. One-piece construction provides added stability and strength.

REMOVABLE BACKREST



OEM					
IMAGE	PART NUMBER	DESCRIPTION	HEIGHT	BEND	PACK QUANTITY
A	3760060	BACKREST BASE - 4.5" x 2"	-	-	20 BULK
B	3760060-ND	NO-DRAIN BASE - 4.5" x 2"	-	-	20 BULK
D	3760063	REMOVABLE BACKREST, ANGLED 1/2"	14-5/8"	10°	10 BULK
C	3760063-ST	STRAIGHT REMOVABLE BACKREST	14-5/8"	-	10 BULK
-	3760065	REMOVABLE BACKREST, ANGLED DRAINING	14-5/8"	22°	10 BULK
-	3760066-L	REMOVABLE BACKREST, TWIST LEFT	14-5/8"	15°	10 BULK
-	3760066-R	REMOVABLE BACKREST, TWIST RIGHT	14-5/8"	15°	10 BULK
-	3760067	REMOVABLE BACKREST, ANGLED	16-5/8"	22°	10 BULK

Constructed from high-strength aluminum with a fine satin brite dip finish. Plastic nylon inserts provide a secure and snug fit. Drain tube allows water to escape from the base. Ball detent for secure contact and unintentional detachment.

- Requires 6-1/2" below deck
- Custom lengths available upon request

SLIDE-OUT FOOTREST



RETAIL			
IMAGE	PART NUMBER	DESCRIPTION	PACK QUANTITY
A	1580074	SLIDE-OUT FOOTREST	1 RETAIL

Large 20" x 7" polyboard platform with grooves, slides 8" in and out. Aluminum mounting collar with black krinkle finish and a plastic bushing to fit 4" diameter pedestals.

- Easy slide in / out
- Bushings available to fit 2-7/8" and 3-1/2" posts (sold separately)

DROP-DOWN FOOTREST

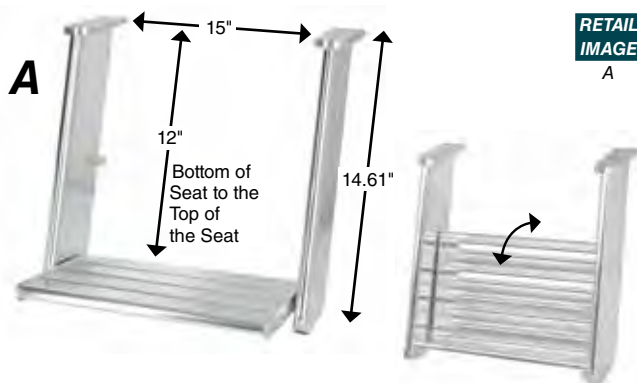

RETAIL			
IMAGE	PART NUMBER	DESCRIPTION	PACK QUANTITY
A	1580030	DROP DOWN - 8-1/2" x 13-1/2" PLATFORM	1 RETAIL

Mounts to bottom of chair. Made from polished high-strength aluminum.

- Hardware not included
- Footrest flips up for out-of-the-way clearance

FOOTREST & BUSHING PACKAGE



IMAGE SIZE	A BLACK	B CAST	C Gray	D BLACK	RETAIL PACK QUANTITY
2-7/8"	-	1580014*	-	-	1 RETAIL
2-7/8"	1580017-BLK	1580017	1580017-G	-	1 RETAIL
3-1/2"	-	1580021	-	-	1 RETAIL
4"	1580022-BLK	-	1580022	-	1 RETAIL
ALL	-	-	-	1580010	1 RETAIL

Footrest easily mounts to several sized pedestals. Split design allows mounting without removing seat. Internal composite bushing prevents scratching of pedestal.

* #1580014: is equipped with a thin bushing

Replacement Bushings

SIZE	ONE PACK ONLY	
	IMAGE	PART NUMBER
2-3/8"		2171044
2-7/8"		2171041
3-1/2"		2171042
4"		2171040

Replacement Collar

ONE PACK ONLY	
IMAGE	PART NUMBER
	2170095-BLK
Fits All Replacement Bushings	

CAST ALUMINUM FOOTREST



RETAIL IMAGE	PART NUMBER	DESCRIPTION	SIZE	PACK QUANTITY
A	1580040	FOOTREST LARGE, FIXED	4"	1 RETAIL
B	1580045	FOOTREST LARGE, FLIP-UP	4"	1 RETAIL
C	1580048	FOOTREST CHAIR MOUNTED, FLIP-UP	4"	1 RETAIL

(A and B) High-strength cast aluminum with black powder-coat finish and cast-in anti-slip grooves. Extends 20" out from center of post

- Fits 4" post
- Bushings available to fit 2-7/8" and 3-1/2" posts (sold separately)

(C) High-strength cast aluminum with black powder-coat finish and cast-in anti-slip grooves. Footrest mounts to bottom of seat.

- Fits 4" post
- Adjustable footrest locations
- Best used with height adjustable pedestals
- Bushings available to fit 2-7/8" and 3-1/2" posts (sold separately)

B and C Platform pivots up for out-of-the-way stowage.

STAINLESS STEEL & ALUMINUM FOOTREST

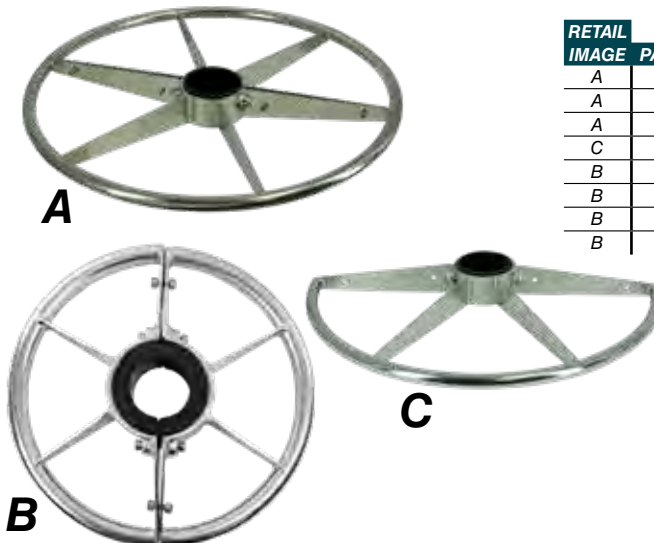

RETAIL IMAGE	PART NUMBER	DESCRIPTION	FINISH	BUSHING	PACK QUANTITY
A	1580080-AL	28" FULL ROUND FOOTREST	ALUMINUM	4"	1 RETAIL
A	1580095-AL	28" HALF ROUND FOOTREST	ALUMINUM	4"	1 RETAIL
A	1580080-SS	28" FULL ROUND FOOTREST	STAINLESS STEEL	4"	1 RETAIL
C	1580095-SS	HALF ROUND FOOTREST	STAINLESS STEEL	4"	1 RETAIL
B	1580087-SS	14" FULL ROUND FOOTREST	STAINLESS STEEL	2-7/8"	1 RETAIL
B	1580087-AL	14" FULL ROUND FOOTREST	ALUMINUM	2-7/8"	1 RETAIL
B	1580082-SS	14" FULL ROUND FOOTREST	STAINLESS STEEL	2-7/8"	1 RETAIL
B	1580082-AL	14" FULL ROUND FOOTREST	ALUMINUM	2-7/8"	1 RETAIL

(A) 28" Round 2-piece footrest available as 316 electro polished stainless steel or anodized polished aluminum. Accepts bushings to fit 2-7/8", 3-1/2", and 4" posts. 1" round rail with 1/8" thick vertical spokes.

(B) 14" Round 2-piece footrest available as 316 electro polished stainless steel or anodized polished aluminum. Accepts bushings to fit 2-3/8" and 2-7/8" posts. 1" round rail with 1/8" thick vertical spokes.

(C) Half round footrest with mounting collar available as 316 electro polished stainless steel or anodized polished aluminum. Accepts bushings to fit 2-7/8", 3-1/2", and 4" posts. 1" round rail with 1/8" thick vertical spokes.

5-LEGGED DECK BASE



RETAIL			
IMAGE	PART NUMBER	DESCRIPTION	PACK QUANTITY
A	1580550-BLK	5-LEGGED DECK BASE	1 RETAIL
B	2100332-01	FLOOR POD	5 RETAIL
C	2100340	LOCKING 75MM CASTER	5 RETAIL

33" Diameter 5-legged deck base with pre-drilled 5/16"-18 tap mounting plate to accept any Springfield® Marine 12" or 9" round pedestal base.

- Approximately 4" high with floor pods or 6" high with casters
- (A) does not come with casters or pods, base only

FOLDING LEG



RETAIL HEIGHT	STAINLESS STEEL	ALUMINUM	PACK QUANTITY
11-1/2"	1081115-SS	1081115	10 BULK
13"	1081135-SS	1081135	10 BULK

Rubber stopper to prevent scratching of surfaces. Available in 304 stainless steel & brite dip aluminum.

DECK PLATES AND RINGS

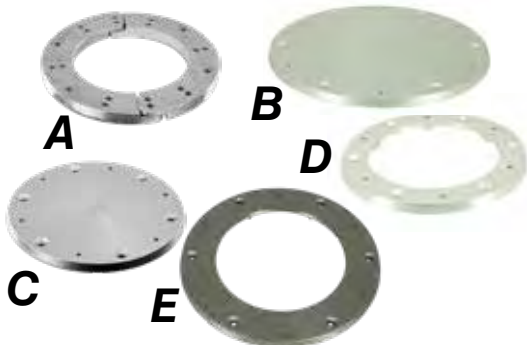

RETAIL					
IMAGE	PART NUMBER	DESCRIPTION	DIAMETER	HOLE PATTERN	PACK QUANTITY
A	1580004	SPLIT UNDER DECK RING	9"	8"	1 RETAIL
B	1580005	ALUMINUM DECK PLATE	12"	11"	1 RETAIL
B	1580005-SS	STAINLESS STEEL DECK PLATE	12"	11"	1 RETAIL
C	1580006	ALUMINUM DECK PLATE	9"	8"	1 RETAIL
D	1580007	ALUMINUM DECK RING	9" OPEN	8"	1 RETAIL
E	1580008	ALUMINUM DECK RING	12" OPEN	11"	1 RETAIL

OEM					
IMAGE	PART NUMBER	DESCRIPTION	DIAMETER	HOLE PATTERN	PACK QUANTITY
A	3580004	SPLIT UNDER DECK RING	9"	8"	10 BULK
B	3580005	ALUMINUM DECK PLATE	12"	11"	10 BULK
C	3580006	ALUMINUM DECK PLATE	9"	8"	10 BULK
-	3580006-P	POLISHED DECK PLATE	9"	8"	10 BULK
D	3580007	ALUMINUM DECK RING	9" OPEN	8"	10 BULK
B	3580012-A	ALUMINUM DECK PLATE	12"	8"	10 BULK
B	3580012-P	POLISHED AL DECK PLATE	12"	8"	10 BULK

Made for non-removable pedestals.

- 9" deck plates have 8" hole pattern
- 12" deck plates have 11" hole pattern (unless noted)

HANDLE ASSEMBLIES & TRAC-LOCK™ SERVICE PARTS



OEM			
IMAGE	PART NUMBER	DESCRIPTION	PACK QUANTITY
A	2100030	2-PIECE POWER PEDESTAL HANDLE	6 BULK
B	2100034	2-3/8" U-STEM HANDLE ASSEMBLY	6 BULK
C	2171062	REMOVABLE AIR-RIDE HANDLE	6 BULK
D	2100095	LOCKING HANDLE FOR 2-7/8" TRAC-LOCK™ SEAT MOUNT	6 BULK
E	2100099	LOCKING HANDLE FOR 2-7/8" TRAC-LOCK™ SEAT MOUNT	6 BULK
F	2100096	AIR-RIDE REPLACEMENT HANDLE	6 BULK
G	2100033	HANDLE FOR QUAD ACTION SWIVEL	6 BULK
H	2171072	TENSION HANDLE FOR TRAC-LOCK™ III	6 BULK
I	2171000	2-3/8" TRAC-LOCK™ II SWIVEL BUSHING, PRE 2002	6 BULK
J	2171001	2-3/8" TRAC-LOCK™ II SWIVEL BUSHING, PRE 2002	6 BULK
K	2170004	SLIDE PADS FOR TRAC-LOCK™ III	6 BULK
L	2171008	2-3/8" TRAC-LOCK™ III SWIVEL BUSHING, 2002 & NEWER	6 BULK
M	2171009	2-7/8" TRAC-LOCK™ III SWIVEL BUSHING, 2002 & NEWER	6 BULK
-	5230073	TRAC-LOCK™ PIVOT BRACKET REPAIR KIT	6 BULK
N	2130099	2-3/8" LOCKING HANDLE ASSEMBLY	6 BULK

Replacement handles and assemblies for air-ride pedestals, seat mounts, etc. Replacement and service parts for Trac-Lock™ seat mounts.

STERN HANDLE

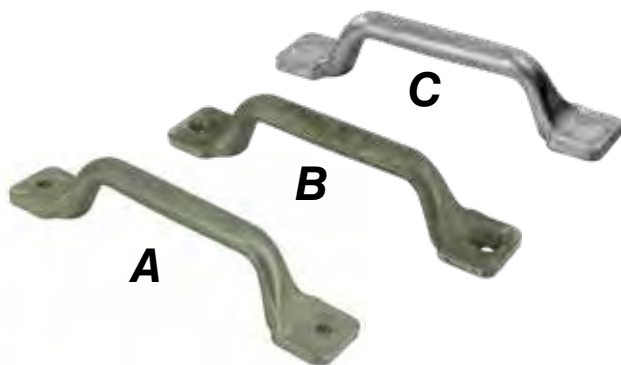

RETAIL			
IMAGE	PART NUMBER	DESCRIPTION	PACK QUANTITY
A	1840054	STERN HANDLE W/PRE-DRILLED HOLES	6 RETAIL

OEM			
IMAGE	PART NUMBER	DESCRIPTION	PACK QUANTITY
A	3840054	STERN HANDLE W/PRE-DRILLED HOLES	100 BULK
B	3840054-CS	STERN HANDLE W/COUNTER SUNK HOLES	100 BULK
C	3840054-NH	STERN HANDLE, NO MOUNTING HOLES	100 BULK

High-strength cast aluminum rugged construction with 6-5/8" distance between mounting holes.

- Extra smooth 6" grip
- Sold in pairs

OARLOCK SOCKETS



RETAIL				
IMAGE	PART NUMBER	DESCRIPTION	BUSHING	PACK QUANTITY
A	1840021	OARLOCK SOCKETS, #20*	9/16"	6 RETAIL

OEM				
IMAGE	PART NUMBER	DESCRIPTION	BUSHING	PACK QUANTITY
A	3840020	OARLOCK SOCKETS, #20	9/16"	100 BULK
A	3840021	OARLOCK SOCKETS, #30	1/2"	100 BULK

Round gunwale sockets with plastic inserts. Fits up to 9/16" oarlocks.

* #1840021: Retail sold in pairs

ROD HOLDERS



RETAIL			
IMAGE	PART NUMBER	DESCRIPTION	PACK QUANTITY
A	1760004	FISHING ROD HOLDERS*	6 RETAIL

OEM			
IMAGE	PART NUMBER	DESCRIPTION	PACK QUANTITY
A	3760004	FISHING ROD HOLDERS	20 BULK

ABS plastic with foam inserts. Holds up to 3 rods and can be installed vertical or horizontal.

* #1760004: Retail sold in pairs

LOCKING SHELF HINGE



RETAIL			
IMAGE	PART NUMBER	DESCRIPTION	PACK QUANTITY
A	1080030	STAINLESS STEEL SHELF HINGES	1 RETAIL

Stainless steel locking shelf hinge had 90° horizontal locking mechanism. Fold shelf down when not in use.

- Sold in pairs as shown

FUEL SEPARATOR COVERS

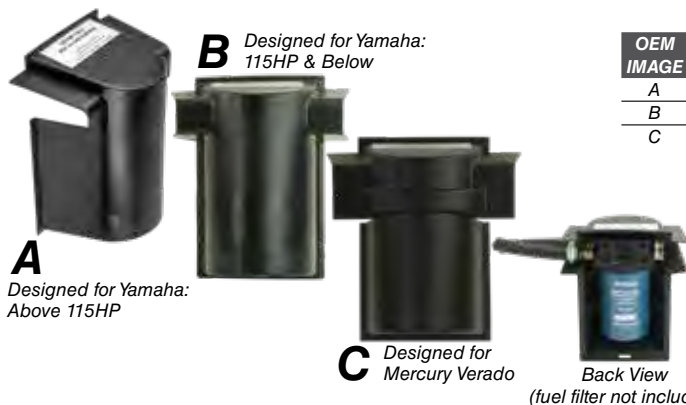

A Designed for Yamaha: Above 115HP

B Designed for Yamaha: 115HP & Below

C Designed for Mercury Verado

Back View
(fuel filter not included)

OEM IMAGE	PART NUMBER	DESCRIPTION	PACK QUANTITY
A	3760022	LARGE - NARROW FUEL SEPARATOR COVER	10 BULK
B	3760025	SMALL FUEL SEPARATOR COVER	10 BULK
C	3760027	SMALL NARROW FUEL SEPARATOR COVER	10 BULK

Made from high-strength injection molded polypropylene used to shield and protect against accidental contact by a tool or the battery terminal during service, installation or removal, and protects from impact and sun damage. Fitted ribs allow quick snap fit and easy access to fuel filter.

- ABYC E-10.7.8 - Each metallic fuel line and fuel system component within 12-inches of the horizontal or vertical plane of the battery surface containing the terminals, as installed, shall be shielded with dielectric material to protect against accidental short-circuiting.

TRANSOM TUFF'NER™



A

B

RETAIL IMAGE	PART NUMBER	DESCRIPTION	SIZE	PACK QUANTITY
A	1780203	HEAVY-DUTY TUFF'NER™	4" x 17"	1 RETAIL
B	1780223	ECONOMY TUFF'NER™	2" x 15"	1 RETAIL

Made of high-strength aluminum, the TRANSOM TUFF'NER™ adds strength and longevity to boats transom by evenly distributing forces during fast starts, high-speed runs, and sharp turns. Easy to install using two bolts (not included) 12-15/16" bolt pattern.

QUICK-CHANGE TRAILER JACK



Trailer Jack In Action

RETAIL IMAGE	PART NUMBER	DESCRIPTION	PACK QUANTITY
A	1840046	TRAILER JACK, FOR WHEEL SIZE 10" - 15"	1 RETAIL

High-strength aluminum construction fits round or square axles and makes elevating your trailer quick, easy, and safe.

- Lifts up to 2 tons

WARNING LABELS

OEM IMAGE	PART NUMBER	DESCRIPTION	PACK QUANTITY
A	8123050	WARNING LABEL, CLASS 'B'	500 BULK
B	8123052	WARNING LABEL, CLASS 'AD'	100 BULK
C	8123060	WARNING LABEL, SKI PYLON	50 BULK
D	2100272-RTS	ARCH WARNING LABEL	250 BULK



A

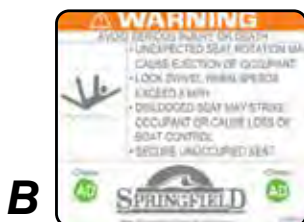

B

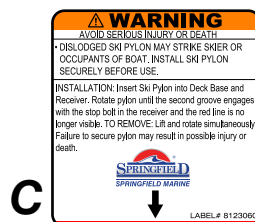

C



D

ACCESSORIES

GUARDIAN MOTOR SUPPORT



Guardian Deluxe



Guardian Standard

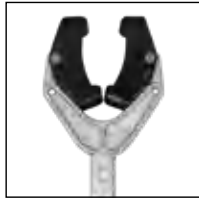

Guardian Economy



V-Block



Over The Roller



Bolt-On



Economy Bolt-On

RETAIL

IMAGE	PART NUMBER	DESCRIPTION	PACK QUANTITY
A	1780238	EXTENDED, OVER THE ROLLER	6 RETAIL
B	1780240	DELUXE COMBO, OVER THE ROLLER & BOLT-ON	6 RETAIL
C	1780242	STANDARD COMBO, OVER THE ROLLER & BOLT-ON	6 RETAIL
D	1780245	ECONOMY COMBO, OVER THE ROLLER & BOLT-ON	6 RETAIL

OEM

IMAGE	PART NUMBER	DESCRIPTION	PACK QUANTITY
E	1780230	V MOUNT, BOLT-ON	10 BULK
F	1780233	DELUXE, OVER THE ROLLER 25" - 37"	10 BULK
A	3780238-01B	EXTENDED, OVER THE ROLLER 40" - 60"	10 BULK
G	3780245-01B	ECONOMY, MOTOR SUPPORT, NO U-BRACE 35.5" - 47"	10 BULK
G	3780245-02B	ECONOMY, MOTOR SUPPORT, NO U-BRACE 20.5" - 33.75"	10 BULK
G	3780245-03B	ECONOMY, OVER THE ROLLER 22" - 34"	10 BULK
G	3780278	ECONOMY, OVER THE ROLLER 30.75" - 50.75"	10 BULK

Cast aluminum head with high-strength aluminum shaft. Supports the cantilevered weight of the motor and stabilizes the engine and steering mechanism when trailering with varying adjustability. Includes 15" black EPDM rubber holding strap. Available in over the roller or bolt-on.

A
Adjusts
33" to 53"

B
Adjusts
25" to 37"

C
Adjusts
20" to 31-1/2"

D
Adjusts
22" to 34"

ACCESSORIES

E
Fixed Height
25"

F
Adjusts
25" to 37"

G
No Trailer Mount
NEW & IMPROVED!
Scratch Resistant
Guards

Measuring
Points

Measuring
Points

Over The Roller

Bolt-On

EXTEND-A-REACH MOTOR SUPPORT



RETAIL			
IMAGE	PART NUMBER	DESCRIPTION	PACK QUANTITY
A	1780250	EXTEND-A-REACH SUPPORT KIT	1 RETAIL

OEM			
IMAGE	PART NUMBER	DESCRIPTION	PACK QUANTITY
A	2100079	EXTEND-A-REACH Y BUSHING	1 BULK

Made of heavy-duty steel with corrosion resistant e-coat finish. Extend-A-Reach secures the motor to trailer crossbar and includes all parts necessary for easy installation. Removes easily for quick loading and unloading.

- Includes 15" black EPDM rubber holding strap
- Adjusts from 26" to 56"



GUARDIAN REPLACEMENT PARTS



A Bolt-On T-Brace
For Guardian Motor Support



B Bolt-On Clevis Pin
(Secures T-Brace To Motor Support)

OEM			
IMAGE	PART NUMBER	DESCRIPTION	PACK QUANTITY
A	2100067	T-BRACE FOR BOLT-ON	6 BULK
B	2100073	BOLT-ON CLEVIS PIN	6 BULK
C	2100074	SUPPORT BUSHING KIT	6 BULK
D	2100075	PLASTIC SWIVELS FOR MOTOR SUPPORT	6 BULK

Replacement parts for Guardian motor supports.



C Replacement Bushing Kit
For Guardian Motor Support



D Replacement Plastic Swivels
For Guardian Motor Support

ACCESSORIES / GRILLS

GRILL PACKAGES



A
Grill Dimensions: 22-3/4"W x 123"D x 7-1/2"H
Legs fold upward to be used as carry handles

IMAGE	PART NUMBER	DESCRIPTION	PACK QUANTITY
A	1940049	GRILL ONLY	1 RETAIL
B	1940052	GRILL WITH THREAD-LOCK™	1 RETAIL
C	1940054	GRILL WITH MULTI-FIT MOUNT KIT	1 RETAIL
D	1940057	GRILL WITH TRAILER HITCH MOUNT	1 RETAIL
E	2100184	RAIL MOUNT WITH MULTI-FIT KIT	1 RETAIL

Retail packed in box with 4-color label

- All models convert to table top grill.
- 189 sq. ft. grill cooking surface
 - 130 sq. ft. griddle surface on top of lid
 - 12,000 BTU rating
 - Use with a 1-lb propane tank (not included)

WARNING:
ALWAYS USE CAUTION WHEN OPERATING GRILL

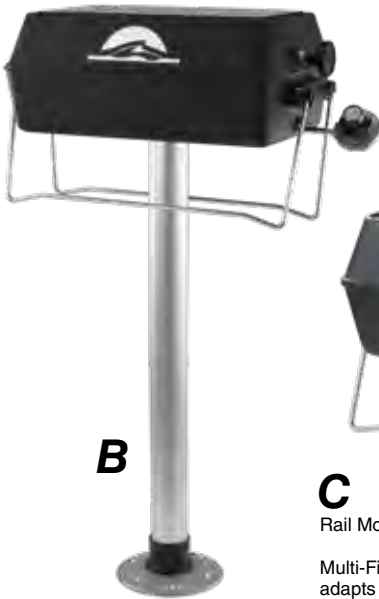

B



C
Rail Mount

Multi-Fit Kit
adapts to the following sizes:



D



E



Rail Mount
Multi-Fit Kit
adapts to the following sizes:



GRILL SERVICE PARTS

ACCESSORIES



A Cooking Grate



B Heat Transfer Plate



C Stainless Steel Burner



D Gas Regulator



E Carrying Handles



F Oil Drain Pan

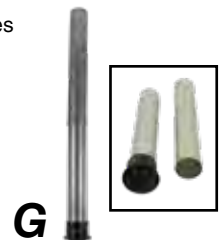

G Thread-Lock™ 2-Piece Post

IMAGE	PART NUMBER	DESCRIPTION	PACK QUANTITY
A	2100145	COOKING GRATE	1 RETAIL
B	2100146	HEAT TRANSFER PLATE	1 RETAIL
C	2100148	STAINLESS STEEL BURNER	1 RETAIL
D	2100149	GAS REGULATOR	1 RETAIL
E	2100151	CARRYING HANDLES	1 RETAIL
F	2100194	OIL DRAIN PAN	1 RETAIL
G	2100147	THREAD-LOCK™ POST 2-PIECE	1 RETAIL

Service and replacement parts for BBQ grill packages

IS YOUR BOAT COMPLIANT?

Springfield Marine Company
is a proud member of these associations and subscribes to the standards and practices which they set forth.

COMPLIANCE



The American Boat and Yacht Council (ABYC) has recommended marine industry seating safety standards for pedestal applications into two separate categories as follows:

Class A Seat designed for occupancy while the boat is underway at any speed.

Class B Seat designed for occupancy only at boat speeds not exceeding five miles per hour (fishing or trolling).

All pedestals must pass a series of tests within each of these classifications which include horizontal and vertical impacts, torque, static load, fatigue, and fastener pull testing.

There are two types of Class A seating designations:

Class AP - Passenger Seat mount must resist 30 foot pounds of torque (non-locking).

Class AD - Driver Seat mount must incorporate a "mechanical interference lock" and resist 150 foot pounds of torque (locking).

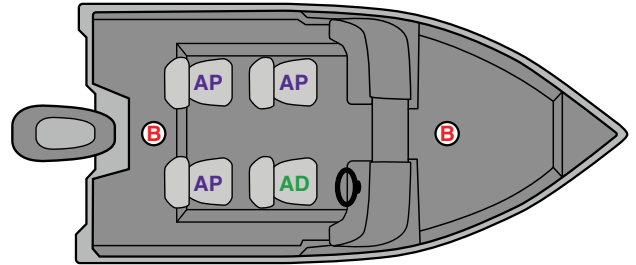

Class B



Class AP



Class AD

Look for these labels to identify the ABYC H-31 Classifications Springfield Marine Company has been a leader in establishing and complying with these ABYC recommended standards.

IN ORDER TO COMPLY WITH THESE STANDARDS, SPRINGFIELD COMPONENTS MUST BE COMBINED WITH OTHER SPRINGFIELD PARTS. MIXING SPRINGFIELD PARTS WITH NON-SPRINGFIELD COMPONENTS VOIDS THESE STANDARD CLASSIFICATIONS.



Plug-In™ Package



Premium Folding Seat



Removable Passenger



Plug-in Power Pedestal

Main Passenger

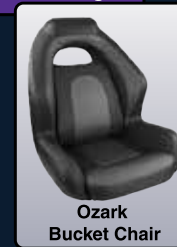

Ozark Bucket Chair



Plug-In™ Air-Ride Sit-down



Skipper Premium Seat



CLASS B



Locking Mainstay Adjustable Pedestal

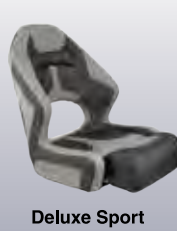

Deluxe Sport Flip-Up II



CLASS AD



Pro Casting Seat



Plug-In™ Air-Ride Stand-up



CLASS B

Driver

Example of multiple parts on typical model boat

PART NUMBER INDEX

PART NUMBER	PAGE	PART NUMBER	PAGE	PART NUMBER	PAGE
-------------	------	-------------	------	-------------	------

PART NUMBER INDEX

PART NUMBER	PAGE	PART NUMBER	PAGE	PART NUMBER	PAGE
-------------	------	-------------	------	-------------	------

PART NUMBER INDEX

PART NUMBER	PAGE	PART NUMBER	PAGE	PART NUMBER	PAGE
1240646-L	71	1250456-LCNS	69	1281106-MAL	75
1240716-L	71	1251315-06	70	1282104-MPL	75
1240729-L	71	1251415-02	70	1300601	50
1240739-L	71	1251415-04	70	1300601-AP	50
1240748-MLNS	69	1251415-04L	70	1300650-L	50
1240749-LNS	69	1252140	69	1300709	51
1240749-MLNS	69	1253031-L	65	1300709-HL1	49
1240750-MLNS	69	1253031-MNS	65	1300709-L1	49
1240751-L1	69	1253032-L	65	1300712	51
1240751-MLNS	69	1253032-L1	65	1300712-HL1	49
1240752-MLNS	69	1253035-MNS	65	1300712-L1	49
1250100	64	1255595-NC	82	1300713	51
1250100-L	64	1260605-MAL	75	1300715	51
1250100-L1	64	1260606-DAL	75	1300715-HL1	49
1250150-L	64	1260607-MAL	75	1300715-L1	49
1250150-L1	64	1260610-DAL	75	1300718	51
1250200-L	64	1260615-DAL	75	1300728	51
1250200-L1	64	1270340-P	80	1300750-1	52
1250206-L	64	1270343-P	80	1300750-A1	52
1250250-L	64	1270346-P	80	1300750-L1	52
1250250-L1	64	1270350-P	80	1300750-R1	52
1250252-L	64	1270354-P	80	1300751-1	52
1250253-L	64	1270640-SS	80	1300754-1	52
1250254-L	64	1270646-SS	80	1300901	49
1250256-L	64	1270650-SS	80	1300902	49
1250300	69	1270710-1DALW	73	1301037	49
1250301	69	1271333-PE	77	1301038	49
1250308-MLNS	65	1271334-PE	77	1303013	49
1250309	65	1271340-PE	77	1304012-HL	51
1250309-L	65	1271349-PE	77	1304015-HL	51
1250309-LNS	65	1271353-PE	77	1310712-L	51
1250309-MLNS	65	1271380-02	70	1310715-L	51
1250310-LNS	65	1271385-01	70	1312700	49
1250310-MLNS	65	1271385-BLK	70	1312701	50
1250312	65	1271640-SSE	77	1440013-SAL	66
1250312-L	65	1271649-SSE	77	1440213	66
1250312-LNS	65	1275580-NC	82	1440213-L	66
1250312-MLNS	65	1276548	81	1440220	66
1250313-L	65	1280104-MAL	75	1440220-L	66
1250313-LNS	65	1280104-MALB	74	1440228	66
1250313-MLNS	65	1280104-MPL	75	1440248	94
1250314-LNS	65	1280104-SAL1	75	1440334	66
1250315	65	1280106-MAL	75	1440607-MAL	66
1250315-L	65	1280106-MALB	74	1440609-MAL	66
1250315-LNS	65	1280106-MPL	75	1440610-MAL	66
1250315-MLNS	65	1280107-MAL	75	1440612-MAL	66
1250321	69	1280108-MAL	75	1440613-MAL	66
1250321-NS	69	1280108-MPL	75	1440615-MAL	66
1250326-NS	69	1280109-MAL	75	1450009-A	80
1250328-NS	69	1280110-MAL	75	1450009-P	80
1250351-MLNS	65	1280606-SS	73	1450012-BLK	79
1250354-MLNS	65	1280608-SS	73	1450012-P	80
1250450-L	69	1280610-SS	73	1450014-P	80
1250456-L	69	1280618-SS	73	1450018-P	80
1250456-LB	74	1280624-SS	73	1450022-P	80
1250456-LC	69	1281104-MAL	75	1450024-P	80

PART NUMBER	PAGE	PART NUMBER	PAGE	PART NUMBER	PAGE
1450028-P	80	1610413-A	39	1641019	58
1450030-P	80	1610413-EC	39	1641037	59
1450626-SSP	80	1610413-OSS	40	1642005	58
1450630-SSP	80	1610415-A	39	1642008	58
1455580-NC	82	1610425-A	39	1643013	59
1457545	81	1611431-A	37	1644513-S	58
1561105	94	1611433	37	1660001	102
1561106	94	1612401-A	36	1660003	101
1561107	94	1612402-A	36	1660004	101
1580004	117	1613401-EC	38	1660017	102
1580005	117	1613402-A	38	1660018-1	102
1580005-SS	117	1614201-PP	38	1660029	100
1580006	117	1615201-EC	38	1660030-A	102
1580007	117	1615204-EC	55	1660032-A	102
1580008	117	1615254-EC	37	1660230	98
1580010	116	1615431-1	36	1660230-BLK	98
1580014	116	1615433-1	36	1660231	98
1580017	116	1620001	40	1660232	98
1580017-BLK	116	1620003	40	1660232-02	98
1580017-G	116	1620004	40	1660236	98
1580021	116	1620005	40	1660237	98
1580022	116	1620016	42	1660238	98
1580022-BLK	116	1620017-S	42	1660701	103
1580030	115	1620018	40	1660702	103
1580040	116	1630001	41	1660703	103
1580045	116	1630001-P	41	1660704-L	103
1580048	116	1630003	41	1661127-CAL	104
1580074	115	1630004	41	1661624	104
1580080-AL	116	1630401-1	36	1661624-P	104
1580080-SS	116	1630402-A	39	1662127	105
1580082-AL	116	1630402-CSS	40	1670002	96
1580082-SS	116	1630402-EC	39	1670002-T	96
1580087-AL	116	1630411-A	39	1670002-U	96
1580087-SS	116	1630415-A	39	1670006	96
1580095-AL	116	1630423-A	39	1670006-GB	96
1580095-SS	116	1630801-A	38	1670006-TB	96
1580550-BLK	117	1630801-EC	38	1670006-U	96
1600003	47	1631037	37	1670008	96
1600005	47	1631038	37	1670008-TB	96
1600008	47	1632012-A	36	1670009	96
1600010	47	1632013-A	36	1670009-GB	96
1600205	46	1633013-A	37	1680203	59
1600406	46	1640002	61	1680411	60
1600409	46	1640007-CL	61	1680415	60
1600420	44	1640013-CL	61	1690001-AL1	100
1600607	44	1640024-CL	61	1690001-SL	100
1600607-L	44	1640034	108	1690102	97
1600610	46	1640036	108	1690106	97
1601002-L	44	1640202	59	1690106-U	97
1601037	45	1640203	59	1690107	97
1602016	44	1640401	60	1690107-U	97
1603013	45	1640403	60	1690202	97
1603824	45	1640404	60	1690206	97
1603825	45	1640411	60	1690207	97
1610411-A	39	1640425	60	1690727-SL	99
1610411-EC	39	1641009	58	1690901	96

PART NUMBER INDEX

PART NUMBER	PAGE	PART NUMBER	PAGE	PART NUMBER	PAGE
1692027-L1	99	1801240-03	111	2100146	122
1695827-A	100	1801250-03	111	2100147	122
1760004	118	1801250-04	111	2100148	122
1780010	93	1801250-05	111	2100149	122
1780203	119	1801255-03	111	2100151	122
1780223	119	1801255-04	111	2100157	18
1780230	120	1801270-03	111	2100175	42
1780233	120	1801270-04	111	2100184	122
1780238	120	1801275-03	111	2100194	122
1780240	120	1801275-04	111	2100196	23
1780242	120	1801280-03	111	2100272-RTS	119
1780245	120	1801280-04	111	2100300	18
1780250	121	1840021	118	2100332-01	117
1793313	55	1840046	119	2100340	117
1800020	108	1840054	118	2130099	117
1800039-T	108	1840220	91	2170004	117
1800040-T	108	1940049	122	2170095-BLK	116
1800041-T	108	1940052	122	2171000	117
1800043-T	108	1940054	122	2171001	117
1800044	108	1940057	122	2171003	47
1800044-7SS02	109	2100010	62	2171004	47
1800044-SS	108	2100011	62	2171008	117
1800044-SS02	109	2100012	62	2171009	117
1800047	108	2100013	62	2171032	47
1800048	108	2100025	105	2171035	47
1800051-T	108	2100026	42	2171040	116
1800052	108	2100030	117	2171041	116
1800061-T	108	2100031	47	2171042	116
1800066-T	108	2100032	42	2171044	116
1800067-T	108	2100033	117	2171062	117
1800090	107	2100034	117	2171072	117
1800095	107	2100038	62	3042045	114
1800096	107	2100040	62	3042045-EC	114
1800096-02	109	2100055	42	3042045-SS	114
1800096-E	107	2100055-M	42	3042048	114
1800096-EXSS	107	2100067	121	3100007	92
1800097	107	2100073	121	3100009	92
1800235-04	111	2100074	121	3100015-1	93
1800240-02	111	2100075	121	3100018	92
1800240-03	111	2100077	42	3100018-01	92
1800245-03	111	2100079	121	3100019	92
1800250-03	111	2100091	62	3100021-1	71,104
1800250-04	111	2100091-B	62	3100021-CR1	71
1800250-05	111	2100092	56,105	3100021-L1	53,71
1800260-04	111	2100092-B	56,105	3100021-LAR1	71
1800265-04	111	2100093	105	3100023-L	73
1800280-03	111	2100093-B	105	3100031-1	45,50,55,67
1800280-04	111	2100094	42	3100031-L1	45,50,67
1801051-T	109	2100095	117	3100031-LAR1	67
1801057-T	109	2100096	117	3100034	90
1801060-T	109	2100097	93	3100036	90
1801071-T02	109	2100099	117	3100036-BLK	90
1801230-03	111	2100102	98	3100037	90
1801230-04	111	2100104	105	3100038-BLK	90
1801235-04	111	2100115	105	3100039	90
1801240-02	111	2100145	122	3100045	89

PART NUMBER	PAGE	PART NUMBER	PAGE	PART NUMBER	PAGE
3100050	93	3100646	89	3300764-PP1	52
3100050-L	93	3100647	89	3300766	53
3100065-L	77	3100656	89	3300850-A1	53
3100065-L2	77	3100656-01	78	3300900	49
3100075-L	78	3100656-01B	79	3300901	49
3100075-LAR	78	3100657-LAR	78	3300902-AS	49
3100205	91	3100665-01	89,91	3301809	53
3100205-M	91	3100675-L	78	3301812	53
3100207	90	3100676-L	78	3301815	53
3100300	90	3100930-A1	72	3301818	53
3100300-05	90	3100930-A1B	74	3301830	53
3100300-06	90	3100930-A1N	72	3310708-L	51
3100300-M	90	3100931	72	3310709-L	51
3100300-SM	90	3101521-L	72	3310710-L	51
3100318	92	3101521-LAR	72	3310712-L	51
3100319	92	3101521-LARW	72	3310715-L	51
3100360	89	3101521-LARW	72	3310725-L	51
3100360-EXTL	89	3101521-LE	70	3311821	53
3100460-LE1	79	3101521-LW	72	3312701	50
3100521-1	71	3300601	50	3312701-PP	50
3100521-1B	74	3300601-01	50	3580004	117
3100521-CL02	74	3300601-AP	50	3580005	117
3100521-CL03	74	3300601-AP01	50	3580006	117
3100521-CL04N	74	3300651-01L	50	3580006-P	117
3100521-CL2	74	3300709	51	3580007	117
3100521-EL1	70	3300709-HL	51	3580012-A	117
3100521-L1	71	3300710	51	3580012-P	117
3100521-L1B	74	3300712	51	3600002-AB	47
3100521-LAR1	67	3300712-HL	51	3600003	47
3100521-LE1	71	3300713	51	3600005	47
3100521-LL1	71	3300713-HL	51	3600008	47
3100521-LLL1	71	3300714	51	3600010-FT	47
3100521-LS1	71	3300715	51	3600406	46
3100523-L	73	3300715-HL	51	3600409	46
3100523-LAR	73	3300718	51	3600611-8	46
3100525	72	3300724-HL	51	3601002	44
3100525-L	72	3300728	51	3601002-L	44
3100531-1	67	3300728-HL	51	3603825-NS	45
3100531-L1	67	3300750-1	52	3610411-A	39
3100531-LAR1	67	3300750-A1	52	3610411-EC	39
3100534-L	91	3300750-AD1	52	3610411-P	39
3100534-L3M	91	3300750-AL1	52	3610413-A	39
3100534-LSH	91	3300750-AR1	52	3610413-EC	39
3100534-S	91	3300750-D1	52	3610413-OSS	40
3100537-L3	91	3300750-L1	52	3610413-P	39
3100544-E1	89	3300750-R1	52	3610413-PSS	39
3100545	89	3300751-1	52	3610415-A	39
3100545-EW	89	3300752-D	52	3610425-A	39
3100548	91	3300753-1	52	3612402-A	36
3100550-L	93	3300753-K1	52	3613401-EC	38
3100550-SS	79	3300754-1	52	3613402-A	38
3100565-LA	77	3300757-D1	52	3614201-PP	38
3100565-LARA	77	3300757-DK1	52	3614204-PP	38
3100575-L	78	3300758-1	52	3615201-EC	38
3100575-LAR	78	3300759-PP1	52	3615204-EC	38,55
3100646-S	89	3300760	53	3615207-ECB	38

PART NUMBER INDEX

PART NUMBER	PAGE	PART NUMBER	PAGE	PART NUMBER	PAGE
3615254-EC	37	3632013-EC	36	3660018-BLK	99
3620001	40	3633011-SSA	37	3660023	102
3620001-B	40	3633013-A	37	3660024-A	102
3620001-P	40	3633013-SSA	37	3660026-A	102
3620003	40	3640002	61	3660026-P	102
3620004	40	3640002-CLA	61	3660030-A	102
3620005	40	3640007-CL	61	3660032-A	102
3620005-P	40	3640012-CL	61	3660032-P	102
3620011	40	3640012-PASSCL	61	3660037-A	102
3620016	42	3640013-CL	61	3660107	104
3620017-SB	42	3640021-CL	61	3660127-CAL	104
3620018	40	3640022-PPCL	61	3660127-CPL	104
3620024	42	3640023	62	3660207	104
3620025	42	3640024-CL	61	3660324	101
3620760	42	3640024-PPCL	61	3660325	101
3630001	41	3640025-CL	61	3660327	101
3630001-B	41	3640028-CL	61	3660328	101
3630001-PB	41	3640031-PP02	109	3660334	101
3630003	41	3640032-PP	108	3660525	101
3630004	41	3640033-PP	108	3660527	101
3630004-B	41	3640034	108	3660619	102
3630004-BLK	41	3640035	108	3660703	103
3630004-EC	41	3640035-S	108	3660704-L	103
3630004-ECB	41	3640036	108	3660727	103
3630005	41	3640036-PP	108	3660727-L	103
3630005-PB	41	3640038	108	3662027	105
3630006-PB	41	3640039	108	3662030	105
3630007-NB	41	3640039-02	109	3662031	105
3630010	42	3640040	108	3663027	105
3630017-ECB	41	3640040-02	109	3663030	105
3630019	41	3640040-PP02	109	3664230-RV	104
3630020	41	3640041-PP	108	3664250-RV	104
3630020-NB	41	3640045-S	108	3664275-RV	104
3630020-OS	41	3640047-S	108	3664300-RV	104
3630020-OSNB	41	3640202	59	3670702	97
3630024	42	3640203	59	3670703	97
3630025	42	3640401	60	3670720	97
3630402-A	39	3640411	60	3680012-PASSCL	62
3630402-CSS	40	3640413	60	3680013-CL	62
3630402-EC	39	3640415	60	3680038-CL	62
3630402-P	39	3640420	62	3680203	59
3630402-PSS	39	3640425	60	3680411	60
3630402-SSA	39	3640430	60	3680413	60
3630409-P	39	3640511-A	60	3680415	60
3630411-A	39	3640513-A	60	3680422	60
3630413-SS	39	3641007	58	3690001-AL	100
3630414-A	39	3641013	58	3690001-ALB	99
3630414-EC	39	3641508-AS	58	3690001-BLKL	100
3630416-A	39	3642507-BAS	58	3690001-SL	100
3630423-A	39	3660002	102	3690007	105
3630423-P	39	3660003	101	3690007-A	105
3630801-A	38	3660004	101	3690007-P	105
3630801-EC	38	3660004-SM	101	3691014-L	99
3632012-A	36	3660017	102	3691025-L	99
3632012-EC	36	3660017-BLK	102	3691027	99
3632013-A	36	3660018	102	3691027-L	99

NOTES

PART NUMBER	PAGE
3691028-L	99
3692027-L	99
3692027-LB	99
3692027-LU	99
3692029-L	99
3692700	100
3760004	118
3760022	119
3760025	119
3760027	119
3760040	96
3760060	115
3760060-ND	115
3760063	115
3760063-ST	115
3760065	115
3760066-L	115
3760066-R	115
3760067	115
3760215-SS	100
3760250	108
3760250-02	109
3760710-P	97
3780238-01B	120
3780245-01B	120
3780245-02B	120
3780245-03B	120
3780278	120
3793010-A	56
3793012-A	56
3793013-A	56
3793213	56
3796010-AL	56
3840020	118
3840021	118
3840045-SS	74
3840054	118
3840054-CS	118
3840054-NH	118
3840220	91
5191131	72
5230073	117
7100170	96,105
7100170-W	105
8123050	119
8123052	119
8123060	119

The entire content of this catalog, including but not limited to images, text, code, materials and other components or elements herein are copyrighted materials owned by Springfield Marine or other third parties, and are protected by United States, worldwide copyright and trademark laws and treaty provisions. Therefore, you may not use, copy, reproduce, publish, modify, transmit, upload or distribute the contents or elements of this catalog in any way without Springfield Marine's express prior written permission. This catalog may be used for informational purposes, online ordering of products, creating and accessing Springfield Marine's user accounts; but, may not be used to commercialize or market any product or service without our express written permission. Permission is granted to electronically copy and print hard copy portions of this catalog for the sole purpose of placing an order with the Springfield Marine website and/or user account; thus, solely for your own non-commercial use. Except as expressly provided herein, Springfield Marine does not grant to users or individuals who access this catalog any express or implied rights under any patents, copyright, trademarks, or trade secrets. Copy of any portion of this catalog thereof must be maintained in an unchanged fashion, include the copyright notices as it appears on this catalog. ALL RIGHTS ARE HEREBY EXPRESSLY RESERVED.

MAKING BOATING BETTER

1093 N. CYNTHIA DRIVE, SUITE 1
NIXA, MO 65714

sales@springfieldgrp.com
WWW.SPRINGFIELDGRP.COM

